

# KOHLER Courage<sup>®</sup>

SV710-SV740

# KOHLER Courage PRO<sup>®</sup>

SV810-SV840

## Owner's Manual

EN

ESS

FRC

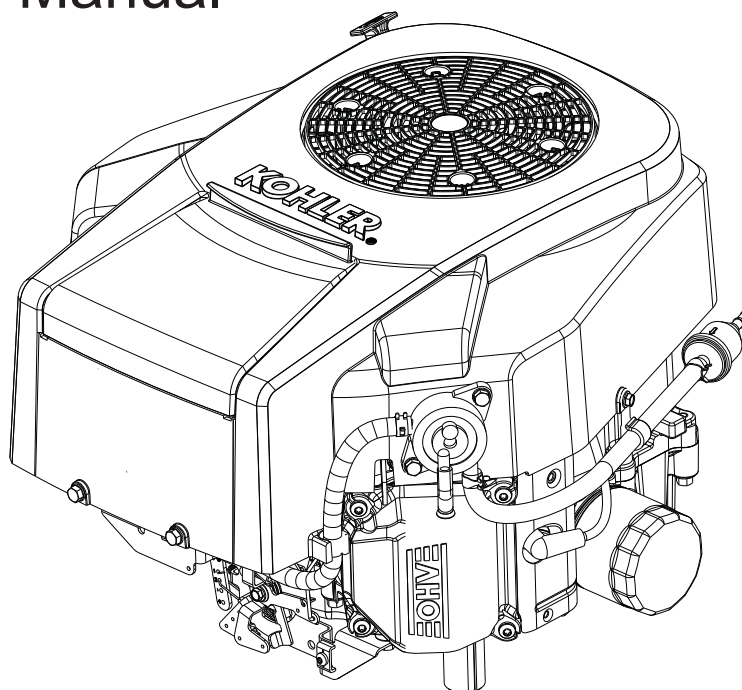

---

**IMPORTANT:** Read all safety precautions and instructions carefully before operating equipment. Refer to operating instruction of equipment that this engine powers.

Ensure engine is stopped and level before performing any maintenance or service.

Warranty coverage as outlined in the warranty card and on KohlerEngines.com. Please review carefully as it provides you specific rights and obligations.

To maintain compliance with applicable emission regulations, exhaust system backpressure may not exceed limits which can be found on KohlerEngines.com. Search by Model No., select Read More, then select Specs tab.

---

Record engine information to reference when ordering parts or obtaining warranty coverage.

Engine Model \_\_\_\_\_

Specification \_\_\_\_\_

Serial Number \_\_\_\_\_

Purchase Date \_\_\_\_\_

## Safety Precautions

**⚠ WARNING:** A hazard that could result in death, serious injury, or substantial property damage.

**⚠ CAUTION:** A hazard that could result in minor personal injury or property damage.

NOTE: is used to notify people of important installation, operation, or maintenance information.

	<b>⚠ WARNING</b>
	<p>Explosive Fuel can cause fires and severe burns.</p> <p>Do not fill fuel tank while engine is hot or running.</p>
<p>Gasoline is extremely flammable and its vapors can explode if ignited. Store gasoline only in approved containers, in well ventilated, unoccupied buildings, away from sparks or flames. Spilled fuel could ignite if it comes in contact with hot parts or sparks from ignition. Never use gasoline as a cleaning agent.</p>	

	<b>⚠ WARNING</b>
	<p>Carbon Monoxide can cause severe nausea, fainting or death.</p> <p>Avoid inhaling exhaust fumes.</p>
<p>Engine exhaust gases contain poisonous carbon monoxide. Carbon monoxide is odorless, colorless, and can cause death if inhaled.</p>	

	<b>⚠ WARNING</b>
	<p>Accidental Starts can cause severe injury or death.</p> <p>Disconnect and ground spark plug lead(s) before servicing.</p>
<p>Before working on engine or equipment, disable engine as follows: 1) Disconnect spark plug lead(s). 2) Disconnect negative (-) battery cable from battery.</p>	

	<b>⚠ WARNING</b>
	<p>Rotating Parts can cause severe injury.</p> <p>Stay away while engine is in operation.</p>
<p>Keep hands, feet, hair, and clothing away from all moving parts to prevent injury. Never operate engine with covers, shrouds, or guards removed.</p>	

	<b>⚠ CAUTION</b>
	<p>Electrical Shock can cause injury.</p> <p>Do not touch wires while engine is running.</p>

	<b>⚠ WARNING</b>
	<p>Hot Parts can cause severe burns.</p> <p>Do not touch engine while operating or just after stopping.</p>
<p>Never operate engine with heat shields or guards removed.</p>	

### California Proposition 65 Warning

Engine exhaust from this product contains chemicals known to State of California to cause cancer, birth defects, or other reproductive harm.

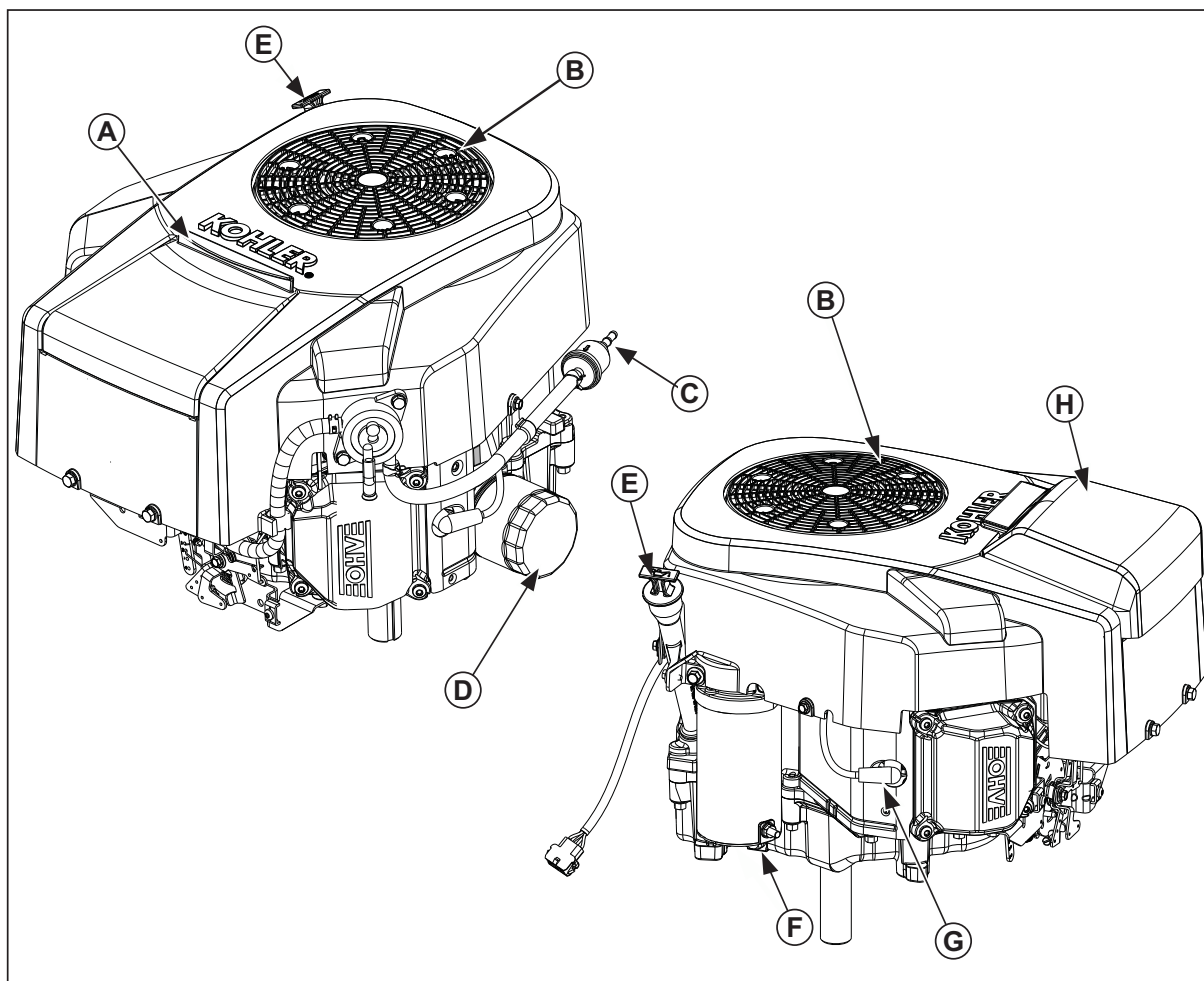

<b>A</b>	Air Cleaner Access Door	<b>B</b>	Debris Screen	<b>C</b>	Fuel Filter	<b>D</b>	Oil Filter
<b>E</b>	Oil Fill/Dipstick	<b>F</b>	Oil Drain Plug	<b>G</b>	Spark Plug	<b>H</b>	Raised Air Cleaner Access Door

### Pre-Start Checklist

1. Check oil level. Add oil if low. Do not overfill.
2. Check fuel level. Add fuel if low. Check fuel system components and lines for leaks.
3. Check and clean cooling areas, air intake areas and external surfaces of engine (particularly after storage).
4. Check that air cleaner components and all shrouds, equipment covers, and guards are in place and securely fastened.
5. Check spark arrestor (if equipped).

## Starting



### **WARNING**

Carbon Monoxide can cause severe nausea, fainting or death. Avoid inhaling exhaust fumes.

Engine exhaust gases contain poisonous carbon monoxide. Carbon monoxide is odorless, colorless, and can cause death if inhaled.



### **WARNING**

Rotating Parts can cause severe injury. Stay away while engine is in operation.

Keep hands, feet, hair, and clothing away from all moving parts to prevent injury. Never operate engine with covers, shrouds, or guards removed.

Refer to operating instructions of equipment this engine powers for specific starting instructions.

## Cold Weather Starting Hints

1. Use proper oil for temperature expected.
2. Disengage all possible external loads.
3. Use fresh winter grade fuel. Winter grade fuel has higher volatility to improve starting.

## Stopping

1. If possible, remove load by disengaging all PTO driven attachments.
2. Position throttle control between half and full throttle; stop engine.

## Angle of Operation

Refer to operating instructions of equipment this engine powers. Do not operate this engine exceeding maximum angle of operation; see specification table. Engine damage could result from insufficient lubrication.



## Engine Speed

**NOTE:** Do not tamper with governor setting to increase maximum engine speed. Overspeed is hazardous and will void warranty.

## High Altitude Operation

This engine may require a high altitude carburetor kit to ensure correct engine operation at altitudes above 4000 ft. (1219 meters). To obtain high altitude kit information or to find a Kohler authorized dealer visit [KohlerEngines.com](http://KohlerEngines.com) or call 1-800-544-2444 (U.S. and Canada).

This engine should be operated in its original configuration below 4000 ft. (1219 meters) as damage may occur if high altitude carburetor kit is installed and operated below 4000 ft. (1219 meters).

	 <b>WARNING</b>	Before working on engine or equipment, disable engine as follows: 1) Disconnect spark plug lead(s). 2) Disconnect negative (-) battery cable from battery.
	Accidental Starts can cause severe injury or death. Disconnect and ground spark plug lead(s) before servicing.	

Normal maintenance, replacement or repair of emission control devices and systems may be performed by any repair establishment or individual; however, warranty repairs must be performed by a Kohler authorized dealer found at KohlerEngines.com or 1-800-544-2444 (U.S. and Canada).

**Maintenance Schedule**

Every 25 Hours<sup>1</sup>

- Service/replace precleaner.
- Replace air cleaner element (if not equipped with precleaner).

Every 100 Hours<sup>1</sup>

- Replace air cleaner element (if equipped with precleaner).
- Change oil and filter.
- Remove cooling shrouds and clean cooling areas.

Every 100 Hours

- Check that all fasteners are in place and components are properly secured.
- Replace fuel filter.

Every 200 Hours<sup>2</sup>

- Have valve lash checked/adjusted.

Every 500 Hours

- Replace spark plugs and set gap.

<sup>1</sup> Perform these procedures more frequently under severe, dusty, dirty conditions.

<sup>2</sup> Have a Kohler authorized dealer perform this service.

**Oil Recommendations**

We recommend use of Kohler oils for best performance. Other high-quality detergent oils (including synthetic) of API (American Petroleum Institute) service class SJ or higher are acceptable. Select viscosity based on air temperature at time of operation as shown in table below.

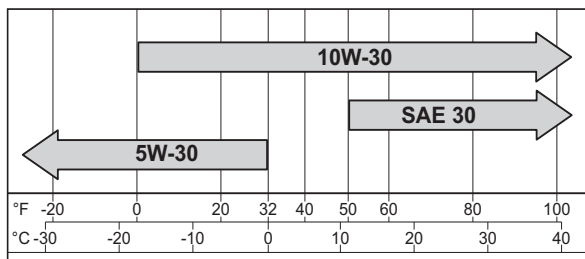

**Check Oil Level**

**NOTE:** To prevent extensive engine wear or damage, never run engine with oil level below or above operating range indicator on dipstick.

Ensure engine is cool. Clean oil fill/dipstick areas of any debris.

1. Remove dipstick; wipe oil off.
  - a. Push-in cap: reinsert dipstick into tube; press completely down.
  - or
  - b. Threaded cap: reinsert dipstick into tube and thread on completely.
2. Remove dipstick; check oil level. Level should be at top of indicator on dipstick.
3. If oil is low on indicator, add oil up to top of indicator mark.
4. Reinstall and secure dipstick.

## Change Oil and Filter

Change oil while engine is warm.

1. Clean area around oil fill cap/dipstick. Remove drain plug and oil fill cap/dipstick. Allow oil to drain completely.
2. Clean area around oil filter. Place a container under filter to catch any oil and remove filter. Wipe off mounting surface. Reinstall drain plug. Torque to 10 ft. lb. (13.6 N·m).
3. Place new filter in shallow pan with open end up. Fill with new oil until oil reaches bottom of threads. Allow 2 minutes for oil to be absorbed by filter material.
4. Apply a thin film of clean oil to rubber gasket on new filter.
5. Refer to instructions on oil filter for proper installation.
6. Fill crankcase with new oil. Level should be at top of indicator on dipstick.
7. Reinstall oil fill cap/dipstick and tighten securely.
8. Start engine; check for oil leaks. Stop engine; correct leaks. Recheck oil level.
9. Dispose of used oil and filter in accordance with local ordinances.

## Oil Sentry™ (if equipped)

This switch is designed to prevent engine from starting in a low oil or no oil condition. Oil Sentry™ may not shut down a running engine before damage occurs. In some applications this switch may activate a warning signal. Read your equipment manuals for more information.

## Fuel Recommendations

	<b>! WARNING</b>
	Explosive Fuel can cause fires and severe burns. Do not fill fuel tank while engine is hot or running.
Gasoline is extremely flammable and its vapors can explode if ignited. Store gasoline only in approved containers, in well ventilated, unoccupied buildings, away from sparks or flames. Spilled fuel could ignite if it comes in contact with hot parts or sparks from ignition. Never use gasoline as a cleaning agent.	

NOTE: E15, E20 and E85 are NOT approved and should NOT be used; effects of old, stale or contaminated fuel are not warrantable.

Fuel must meet these requirements:

- Clean, fresh, unleaded gasoline.
- Octane rating of 87 (R+M)/2 or higher.
- Research Octane Number (RON) 90 octane minimum.
- Gasoline up to 10% ethyl alcohol, 90% unleaded is acceptable.
- Methyl Tertiary Butyl Ether (MTBE) and unleaded gasoline blend (max 15% MTBE by volume) are approved.
- Do not add oil to gasoline.
- Do not overfill fuel tank.
- Do not use gasoline older than 30 days.

## Fuel Line

Low permeation fuel line must be installed on carbureted Kohler Co. engines to maintain EPA and CARB regulatory compliance.

## Spark Plugs

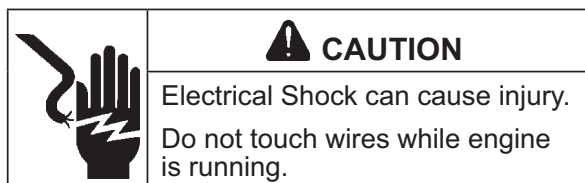

Clean out spark plug recess. Remove plug and replace.

1. Check gap using wire feeler gauge. Adjust gap, see specification table for adjustment.
2. Install plug into cylinder head.
3. Torque plug to 20 ft. lb. (27 N·m).

## Air Cleaner

**NOTE:** Operating engine with loose or damaged air cleaner components could cause premature wear and failure. Replace all bent or damaged components.

**NOTE:** Paper element cannot be blown out with compressed air.

Open air cleaner access door on blower housing and unhook latch.

Precleaner (if equipped):

1. Remove precleaner.
2. Replace or wash precleaner in warm water with detergent. Rinse and allow to air dry.
3. Saturate precleaner with new engine oil; squeeze out excess oil.
4. Reinstall precleaner over paper element.

Paper Element:

1. Remove element from base; service precleaner. Discard element.
2. Install precleaner over new paper element and install on base.

Hook latch; close and secure access door.

## Breather Tube

Ensure both ends of breather tube are properly connected.

## Air Cooling

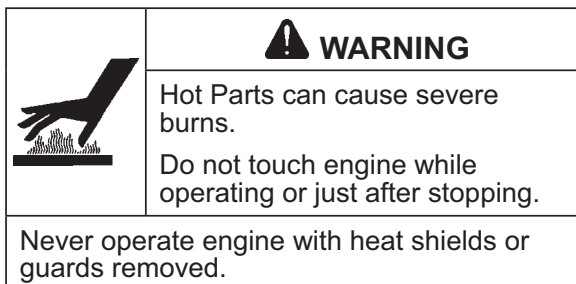

Proper cooling is essential. To prevent over heating, clean screens, cooling fins, and other external surfaces of engine. Avoid spraying water at wiring harness or any electrical components. See Maintenance Schedule.

## Repairs/Service Parts

We recommend that you use a Kohler authorized dealer for all maintenance, service, and replacement parts for engine. To find a Kohler authorized dealer visit [KohlerEngines.com](http://KohlerEngines.com) or call 1-800-544-2444 (U.S. and Canada).

## Storage

If engine will be out of service for 2 months or more follow procedure below.

1. Add Kohler PRO Series fuel treatment or equivalent to fuel tank. Run engine 2-3 minutes to get stabilized fuel into fuel system (failure due to untreated fuel are not warrantable).
2. Change oil while engine is still warm from operation. Remove spark plug(s) and pour about 1 oz. of engine oil into cylinder(s). Replace spark plug(s) and crank engine slowly to distribute oil.
3. Disconnect negative (-) battery cable.
4. Store engine in a clean, dry place.

## Troubleshooting

Do not attempt to service or replace major engine components, or any items that require special timing or adjustment procedures. This work should be performed by a Kohler authorized dealer.

Problem	Possible Cause							
	No Fuel	Improper Fuel	Dirt In Fuel Line	Dirty Debris Screen	Incorrect Oil Level	Engine Overloaded	Dirty Air Cleaner	Faulty Spark Plug
Will Not Start	•	•	•		•	•	•	•
Hard Starting		•	•		•	•	•	•
Stops Suddenly	•		•	•	•	•	•	•
Lacks Power		•	•	•	•	•	•	•
Operates Erratically		•	•	•		•	•	•
Knocks or Pings		•		•		•		•
Skips or Misfires		•	•	•			•	•
Backfires		•	•			•	•	•
Overheats		•	•	•	•	•	•	
High Fuel Consumption						•	•	•

## Engine Specifications

Model	Bore	Stroke	Displacement	Oil Capacity (Refill)	Spark Plug Gap	Maximum Angle of Operation (@ full oil level)*
SV710	3.27 in. (83 mm)	2.6 in. (67 mm)	44.2 cu. in. (725 cc)	1.7-1.9 U.S. qt. (1.6-1.8 L)	0.03 in. (0.76 mm)	25°
SV715						
SV720						
SV725						
SV730						
SV735						
SV740						
SV810						
SV820						
SV830						
SV840						

\*Exceeding maximum angle of operation may cause engine damage from insufficient lubrication.

Additional specification information can be found in service manual at [KohlerEngines.com](http://KohlerEngines.com).

Exhaust Emission Control System for models SV710-SV740 and SV810-SV840 is EM for U.S. EPA, California, and Europe.

Any and all horsepower (hp) references by Kohler are Certified Power Ratings and per SAE J1940 & J1995 hp standards. Details on Certified Power Ratings can be found at [KohlerEngines.com](http://KohlerEngines.com).