

**INTERNATIONAL®
CUB CADET®**

**1000, 1200, 1250,
1450, and 1650
TRACTORS**

INTERNATIONAL®

OPERATOR'S MANUAL

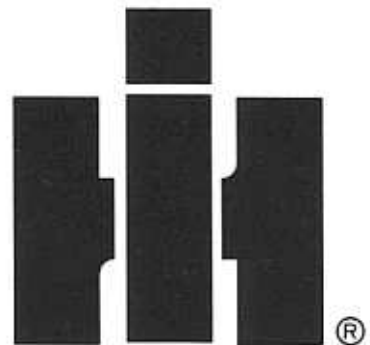

To The Owner

Assembled in this manual are operation, lubrication, and maintenance instructions for the International Cub Cadet 1000, 1200, 1250, 1450, and 1650 Tractors. The material has been prepared in detail to help you better understand the correct care and efficient operation of your tractor. Before you operate the tractor, study this manual carefully. Additional copies may be ordered from your dealer at a nominal price.

Your local International Harvester dealer is interested in the performance you receive from this tractor. He has factory-trained servicemen, informed in the latest method of servicing tractors, modern tools, and original-equipment IH service parts which assure proper fit and good performance.

The International Cub Cadet 1250, 1450, and 1650 Tractors have a hydrostatic drive. It is the best hydrostatic drive unit available and will require minimum service if recommended operation and maintenance procedures are followed.

Should you have difficulties with the unit consult your International Harvester dealer. **UNDER NO CIRCUMSTANCES SHOULD YOU ATTEMPT TO SERVICE THESE UNITS YOURSELF.** Only your dealer is authorized to repair or replace units on this drive under the terms of the warranty. Should you desire additional information not found in this manual, contact your International Harvester dealer.

The International Cub Cadet 1000 and 1200 Tractors have a conventional clutch and transmission.

To obtain top performance and assure economical operation the tractor should be inspected, depending on its use, periodically, or at least once a year, by your International Harvester dealer.

When in need of parts, always specify the model, chassis, and engine serial numbers, including the prefix and suffix letters. Write these serial numbers in the space provided on page 3.

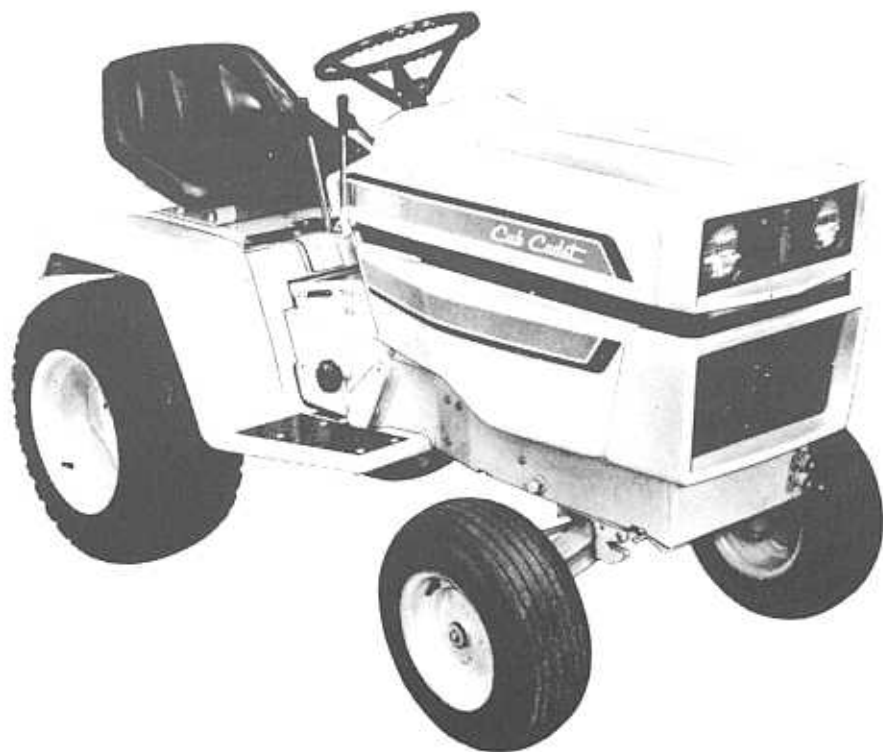

CONTENTS

TO THE OWNER	Inside Cover	International Cub Cadet 1250, 1450, and 1650 Tractors	
DELIVERY SERVICE		Brake pedal	
SERVICE MANUAL INFORMATION		Speed control lever	
CONTENTS	1 2	Starting the tractor	
SERIAL NUMBER LOCATION	3	Release lever	
INTRODUCTION	3	Stopping the tractor	
WORK SAFELY—FOLLOW THESE RULES	4	EQUIPMENT LIFT HANDLE	14
INSTRUMENTS AND CONTROLS	5, 6	Height adjustment	
BEFORE OPERATING YOUR NEW TRACTOR	7	HITCHING EQUIPMENT TO THE TRACTOR	14
OPERATING THE ENGINE	7 to 9	Drawbar	
Throttle lever		Three-point hitch	
Governor		REAR POWER TAKE-OFF	15
Lifting the hood		Operating the rear power take-off with the tractor standing still	
Starting the engine		Operating the rear power take-off with the tractor in motion	
Stopping the engine		FRONT POWER TAKE-OFF	16
FUEL SYSTEM	9, 10	Operating the front power take-off clutch	
Fuel shut-off valve		Adjusting the power take-off clutch	
Carburetor adjustments		ELECTRIC LIFT	16, 17
DRIVING THE TRACTOR	11 to 13	HYDRAULIC LIFT	18
Adjusting the seat		ENGINE COOLING AND AIR CLEANER	19
Clutch and brake pedal		Engine cooling	
Locking the brake		Dry type air cleaner	
International Cub Cadet 1000, and 1200 Tractors			
Clutch-brake pedal			
Gearshift lever			
Starting the tractor			
Stopping the tractor			
Creeper shift lever			
Operating the creeper drive			

CONTENTS

<p>ELECTRICAL SYSTEM</p> <ul style="list-style-type: none"> Ignition switch Safety starting switch Charge indicator Hour meter Spark plug Motor generator Motor generator belt Lights Fuse 	<p>19 to 21</p>	<p>STORING THE TRACTOR</p> <ul style="list-style-type: none"> Removing from storage <p>EXTRA EQUIPMENT AND ACCESSORIES</p> <p>TROUBLE SHOOTING</p> <p>LUBRICATION</p> <p>LUBRICATION TABLE</p> <p>LUBRICATION GUIDE</p> <ul style="list-style-type: none"> International Cub Cadet 1000 and 1200 Tractors <p>LUBRICATION GUIDE</p> <ul style="list-style-type: none"> International Cub Cadet 1250, 1450 and 1650 Tractors <p>SPECIFICATIONS</p>	<p>26, 27</p> <p>27</p> <p>28, 29</p> <p>29, 30</p> <p>31</p> <p>32 to 34</p> <p>35 to 37</p> <p>37 to 40</p>
<p>PNEUMATIC TIRES</p> <ul style="list-style-type: none"> Rear tires Care of tires Inflation Operating pressure for tires Mounting tires on the rim Rear wheel weights Tire chains Overloading 	<p>22</p>		
<p>FRONT WHEELS</p> <ul style="list-style-type: none"> Front quick attaching latch Front wheel toe-in Turning radius 	<p>23</p>		
<p>CLUTCH-BRAKE</p> <ul style="list-style-type: none"> International Cub Cadet 1000, and 1200 Tractors Adjusting the clutch Adjusting the brakes 	<p>24</p>		
<p>BRAKES</p> <ul style="list-style-type: none"> International Cub Cadet 1250, 1450 and 1650 Tractors Adjusting the brakes 	<p>25, 26</p>		

SERIAL NUMBER LOCATION

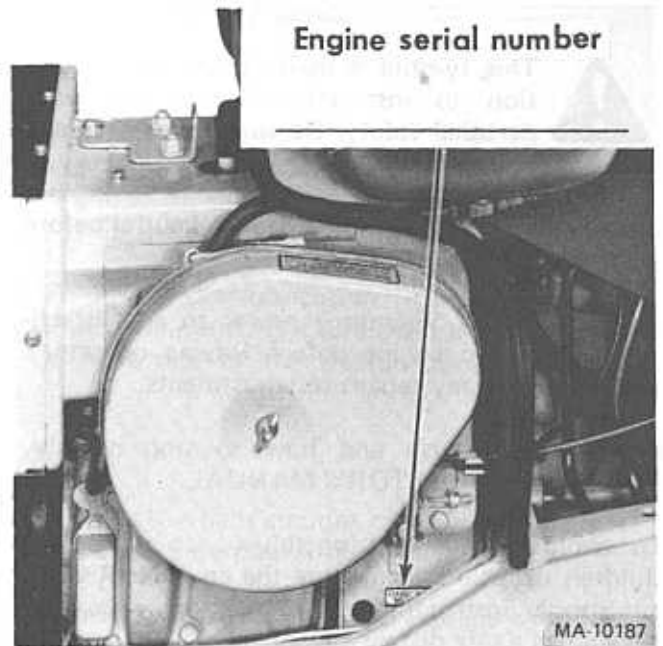
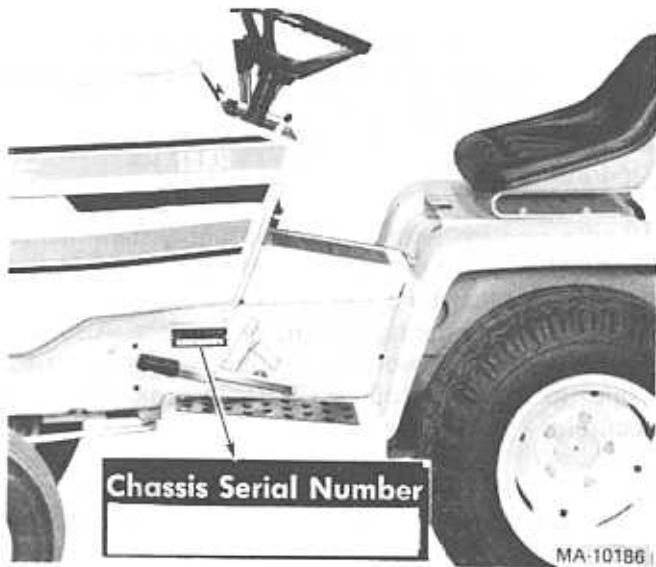

MODEL _____

DELIVERY
DATE _____

"Compliance with Radio Interference Regulations
Certified." (Canada D.O.C.)

INTRODUCTION

A variety of extra equipment and accessories is available. Where operating and maintaining instruction is required, it is included in the instruction for operating and maintaining the tractor. Disregard the instructions for equipment not on your tractor.

LEFT and RIGHT indicate the left and right sides of the tractor when facing forward in the driver's seat. Reference to FRONT indicates the grille end of the tractor; to REAR the drawbar end.

WORK SAFELY – FOLLOW THESE RULES



This symbol is used to call your attention to instructions concerning your personal safety. Be sure to observe and follow these instructions.

Disengage all clutches and shift into neutral before starting the engine.

To avoid injury, disengage power to any attachments and stop engine before leaving operator's seat or making any repairs or adjustments.

Know the controls and how to stop quickly.
READ THE OPERATOR'S MANUAL.

To avoid an accident or injury, do not allow children or adults to operate the equipment without proper instructions. Keep children, pets, and bystanders a safe distance away.

Clear work area of objects which might be picked up and thrown.

Disengage power to any attachment when transporting or not in use.

To prevent an accident, always disengage the power take-off, shift transmission into neutral, set the parking brake, stop the engine, and remove ignition key when leaving the machine unattended.

Reduce speed on slopes and in sharp turns to prevent tipping or loss of control.

Stay alert for holes in terrain and other hidden hazards.

Before backing the tractor, always look for obstacles or bystanders in the area where the tractor will move.

To avoid the possibility of an upset, always engage the clutch slowly, especially on steep slopes. Avoid quick starts and stops.

NO RIDERS! This machine is designed to safely carry only the operator. Do not carry passengers or give rides as serious injury could result.

Use care when pulling loads or using heavy equipment. Use only approved hitch points, and limit loads to those you can safely carry. Use counterweight or wheel weights when suggested in Operator's Manual.

Handle gasoline with care – it is highly flammable:
– A. Use approved gasoline container. B. Never remove the fuel tank cap or fill the fuel tank when the engine is running, is hot, or indoors. Also, do not smoke when working around flammable fuel. Wipe up spilled gasoline. C. Replace gasoline cap securely.

During operation do not run the engine in confined area such as storage building any longer than is necessary for immediate moving of the tractor outside into the air.

Keep machine in good operating condition and keep safety devices in place. Use guards or shields as instructed in Operator's Manual.

It is recommended that the machine be stopped and inspected for damage after striking a foreign object and that any damage be repaired before restarting and operating the machine.

Always turn ignition "OFF", depress the brake pedal, and set the brake pedal lock before working on the machine. Disengage all implements and shift the transmission into neutral.

REMEMBER - A careful operator is the best insurance against an accident.

Avoid Overturns - Back the tractor up the steepest portion of the hill to be mowed! If the tractor cannot do this, the hill is too steep for safe operation. When mowing hills, cut down the face of the hill rather than across to avoid side tipping. Also, avoid sudden starts, stops, and turns, especially on steep slopes to avoid an upset.

Do not allow anyone in the area parallel to the discharge opening while mowing. Although the area has been supposedly cleared of foreign objects, small objects may have been overlooked and may be discharged by the mower causing serious injury.

INSTRUMENTS AND CONTROLS



Your Cub Cadet Tractor has been safety engineered. Thoroughly acquaint yourself with all the instruments and controls before attempting to start or operate the tractor.

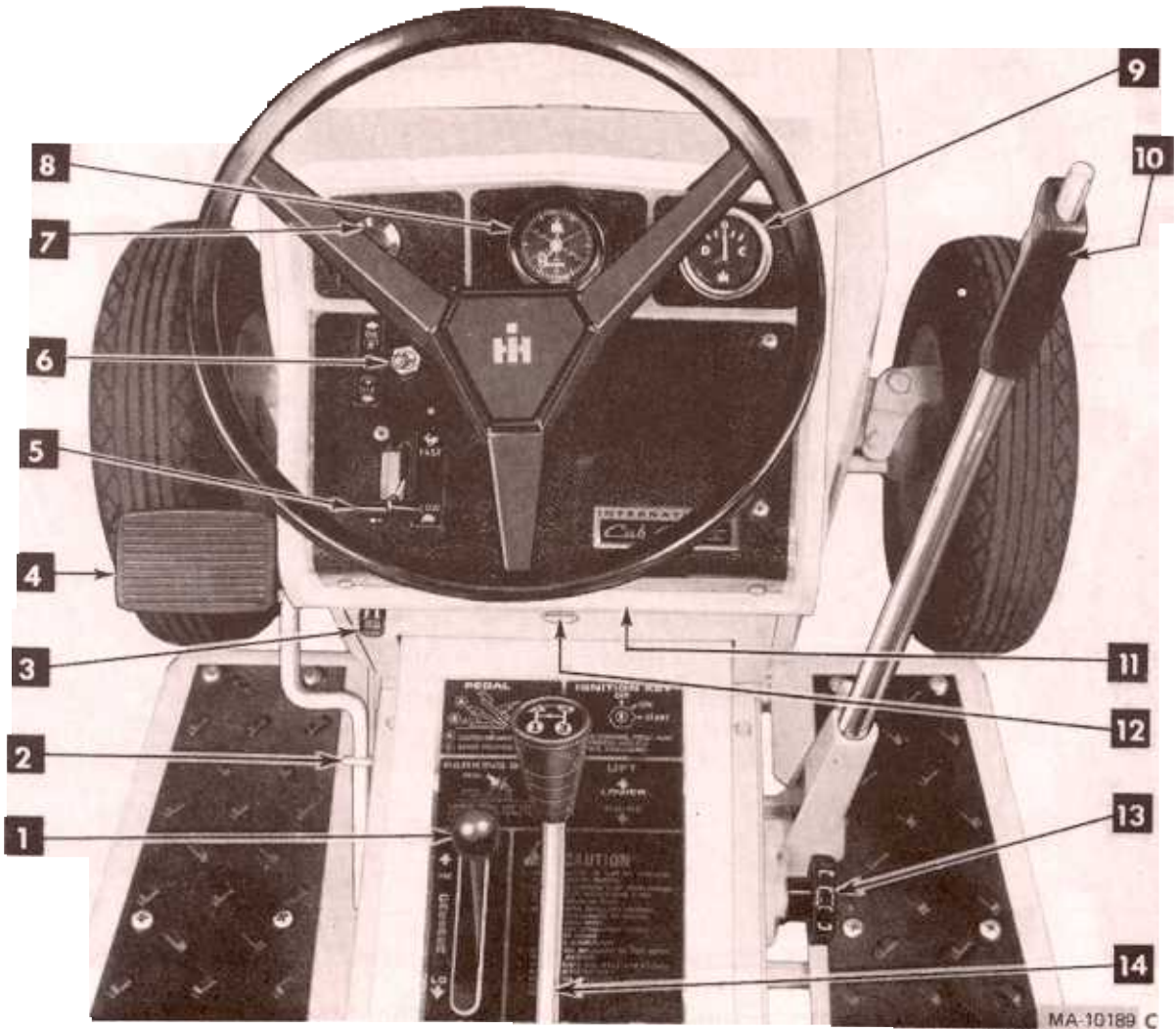

Instruments and controls — International Cub Cadet 1000 and 1200 Tractors

1. Creeper shift lever *	See page 12	8. Hour meter See page 20
2. Brake pedal lock	See page 11	9. Charge indicator See page 20
3. Fuses	See page 20	10. Equipment lift handle See page 14
4. Clutch and brake pedal	See page 11	11. Ignition switch See page 19
5. Throttle lever	See page 12	12. Lighting switch *	
6. Front power take-off control switch	See page 16	13. Lift handle cam stop	See page 14
7. Choke control	See page 8	14. Gear shift lever	See page 11

Optional Equipment

INSTRUMENTS AND CONTROLS

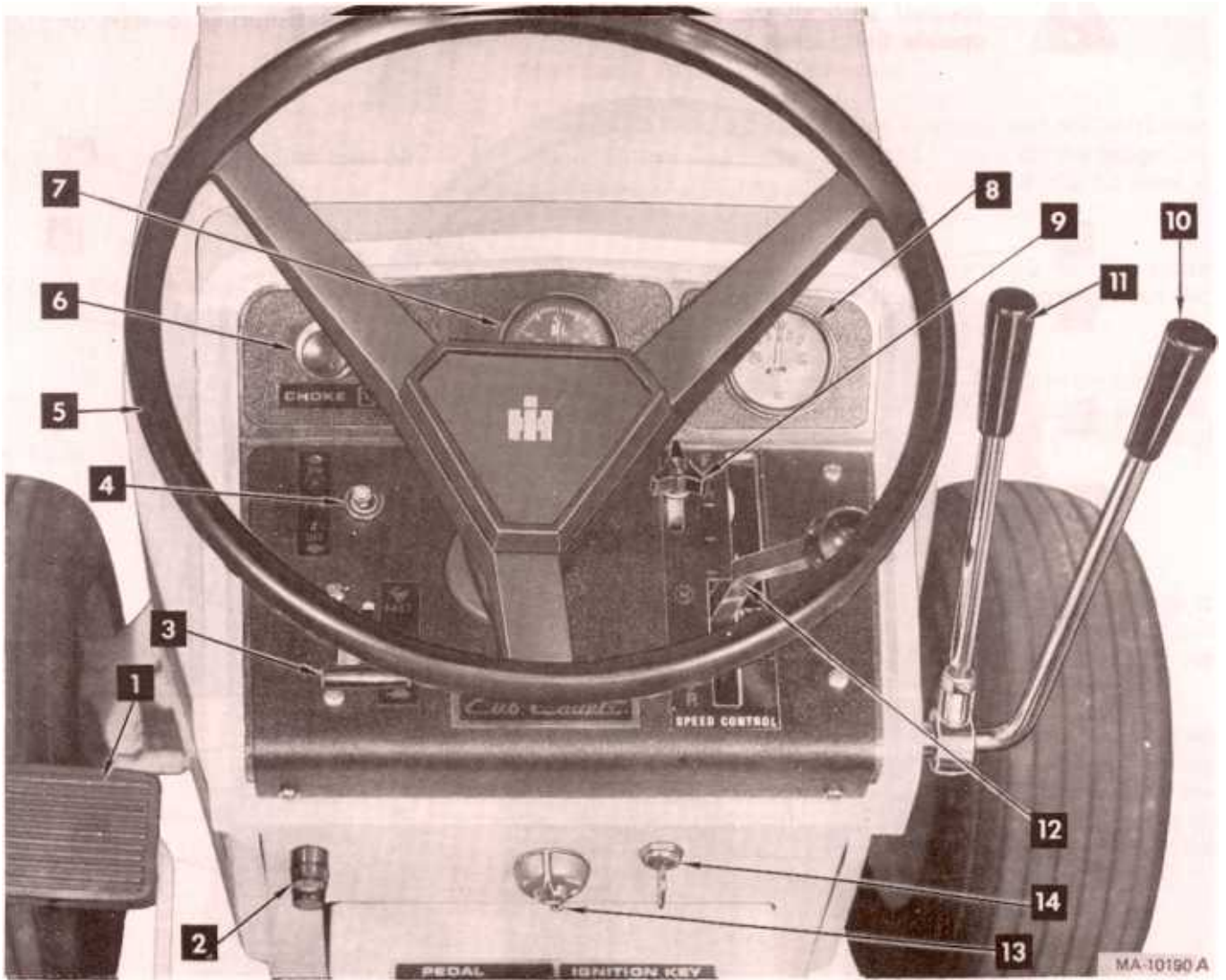

Instruments and controls - International Cub Cadet 1250, 1450, and 1650 Tractors

1. Brake pedal	See page 11	9. Speed Control stop	See page 13
2. Fuses	See page 20	10. Hydraulic front power outlet control lever*	See page 18
3. Throttle lever	See page 12	11. Hydraulic lift control lever	See page 18
4. Front power take-off control switch	See page 16	12. Speed control lever	See page 13
5. Steering wheel		13. Lighting switch * (Standard on Models 1450 and 1650)	
6. Choke control	See page 8	14. Ignition switch	See page 19
7. Hourmeter	See page 20		
8. Charge indicator	See page 20		

* Optional Equipment

BEFORE OPERATING YOUR NEW TRACTOR

- Lubrication Lubricate the entire tractor. See pages 29 to 37.
- Tires Check the air pressure. See page 22.
- Fuel System Fill the fuel tank with gasoline. See pages 9 and 10.

OPERATING THE ENGINE

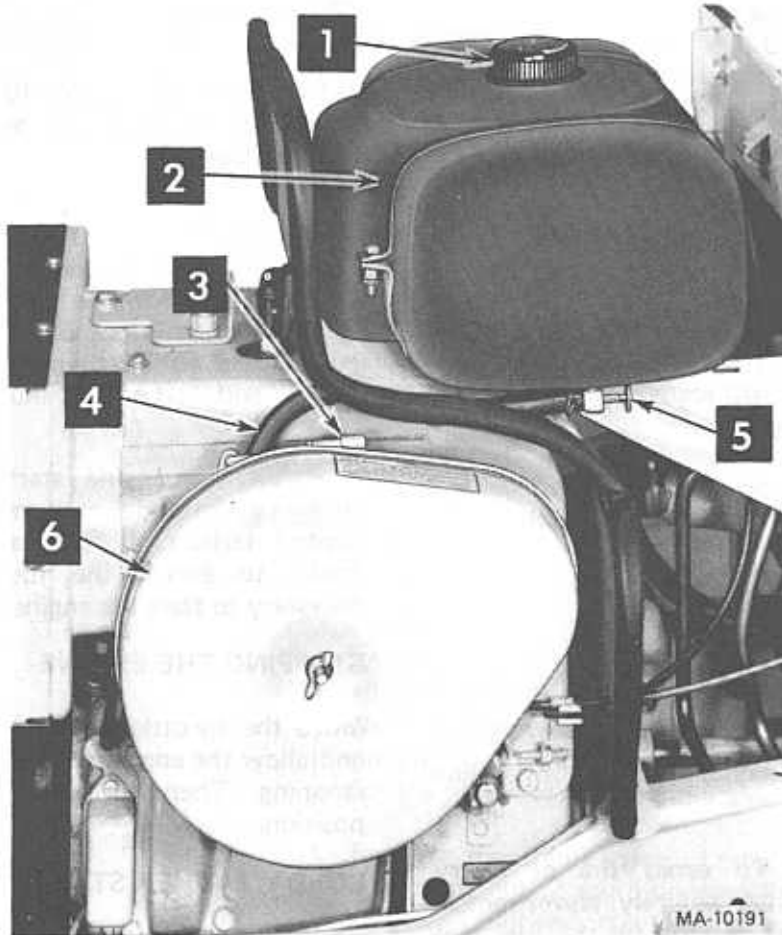

- | | |
|-----------------------------------|------------------------|
| 1. Fuel tank filler cap and gauge | 4. Fuel line |
| 2. Fuel tank | 5. Fuel shut-off valve |
| 3. Carburetor (not seen) | 6. Air cleaner |

Fuel System

THROTTLE LEVER

This lever controls the speed of the engine. When set in a given position, it will maintain a uniform engine speed.

When using power take-off operated equipment, best performance is achieved with the throttle lever in the "FAST" position.

GOVERNOR

The governor is set at the time the engine is assembled and should not require readjustment unless the governor arm is removed or loosened from the governor shaft. Consult your International Harvester dealer if the governor does not function properly.

OPERATING THE ENGINE

HOOD AND NOISE ISOLATION PANELS

The tractor hood is arranged to swing up and forward for easy access to the fuel tank. Also, whenever engine maintenance is required, the noise isolation panels can be readily removed by removing the two thumb screws (one on each side) and disconnecting the panel spring.

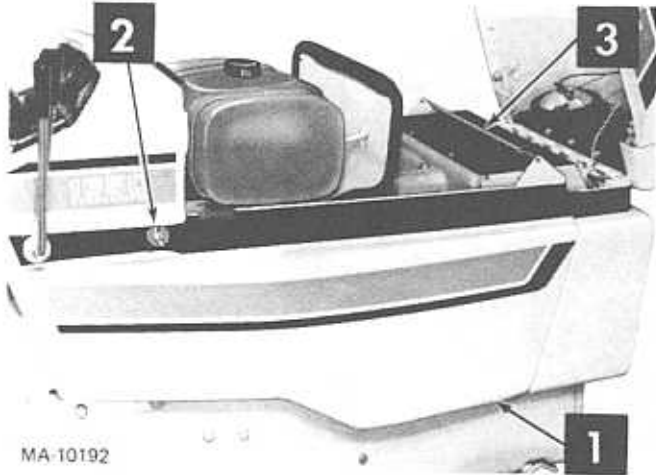

MA-10192

1. Noise isolation panel (one on each side)
2. Thumb screw
3. Panel spring

STARTING THE ENGINE

1. Be sure there is an adequate supply of gasoline in the fuel tank.



CAUTION! To avoid fire or injury, tighten fuel cap securely. Never remove the fuel tank cap or fill the fuel tank when the engine is running, or hot, or indoors. Also, do not smoke when working around flammable fuel.

2. Be sure the fuel shut-off valve is open.
3. Pull choke control button to full choke position. Less choking may be necessary due to variations in temperature, grade of fuel, etc. Little or no choking will be needed when the engine is warm.
4. Place the throttle all the way in, "SLOW" position.

5. To start the engine, safety starting switches must be activated by pressing the clutch-brake pedal all the way down and moving the power take-off clutch switch to the disengaged position.

On the International Cub Cadet 1250, 1450, and 1650 Tractors the speed control lever will return to neutral when the clutch-brake pedal is pressed all the way down.

International Cub Cadet 1000 and 1200 Tractors: Check to see that the gearshift lever is in the neutral position.

All Models: Turn the ignition key clockwise to the "START" position and release it as soon as the engine starts; however do not operate the starter for more than 30 seconds at any one time. If the engine does not start within this time, turn the key "OFF" and wait a few minutes, then try again.

6. After the engine starts, slowly release the clutch-brake pedal and gradually push the choke control button all the way in. Do not use the choke to enrich the fuel mixture, except as necessary to start the engine.

STOPPING THE ENGINE

Move the throttle lever to the "SLOW" position and allow the engine to idle for a short time before stopping. Then turn the key to the "OFF" position.

COLD WEATHER STARTING

Engine starting is possible in cold weather providing the correct weight of engine oil is used, the battery is fully charged, and the proper starting procedure is followed. The best procedure for starting at temperatures near or below freezing is as follows:

1. Pull the choke all the way out into the full choke position.
2. Move the throttle lever downward into the slow position.

OPERATING THE ENGINE

COLD WEATHER STARTING – Continued

3. Press the clutch-brake pedal all the way down and be sure the power take-off switch is in the off position. The safety interlocks will prevent starting unless this is done.

4. Move the key switch into the start position and hold until the engine starts. As soon as the engine starts, slowly push the choke in part way.



CAUTION! During operation do not run the engine in confined area such as storage building any longer than is necessary for immediate moving of the tractor outside into the air.

NOTE: In cold weather the starting motor may disengage prematurely. This is caused by the engine firing once but failing to continue running. If this happens several times, the engine will be flooded and it will be necessary to start as described in Step 5.

5. Leave the throttle in the slow position but push the choke in all the way; then turn the ignition key to the start position and slowly pull the choke out to the position which will cause the engine to start and continue running. If the engine falters after shifting into drive, pull the choke out part way until the engine runs smoothly, then gradually push the choke back in as the engine warms.

FUEL SYSTEM

FUEL SYSTEM

This engine is designed to operate on leaded gasoline with a 93 minimum octane rating or on unleaded gasoline with a 91 minimum octane rating (Research Method).

The use of unleaded gasoline will increase spark plug and valve life, maintain engine performance longer, and reduce rust and corrosion of the engine while stored.

The fuel tank filler cap has an air vent. Keep the vent open at all times to assure proper flow of the fuel.



CAUTION! Do not remove the fuel tank cap or fill the fuel tank when the engine is running, hot, or when near an open flame. Do not smoke when working around flammable fuel, as the air around the tractor is mixed with a highly explosive vapor.

FUEL SHUT-OFF VALVE

Be sure the shut-off valve under the fuel tank is open. Pull out the needle stem (shut-off valve) until the seat on the stem is tight against the stop to prevent leakage or seepage when the valve is in its full-open position.

CARBURETOR ADJUSTMENTS

NOTE: Air cleaner has been removed from illustrations in order to show carburetor.



CAUTION! To avoid injury or an accident, be sure the brake pedal is in the locked position, transmission is in neutral, and the mower is disengaged before adjusting the carburetor.

The carburetor is adjusted at the factory and under normal operating conditions it will not require readjusting. However, if the engine does not operate properly, installation of a new air cleaner is recommended.

NOTE: To prevent possible damage to the carburetor needles, be very careful closing the carburetor needles before basic adjustments are made. Improper adjustment of the carburetor may result in engine damage.

FUEL SYSTEM

CARBURETOR ADJUSTMENTS - Continued

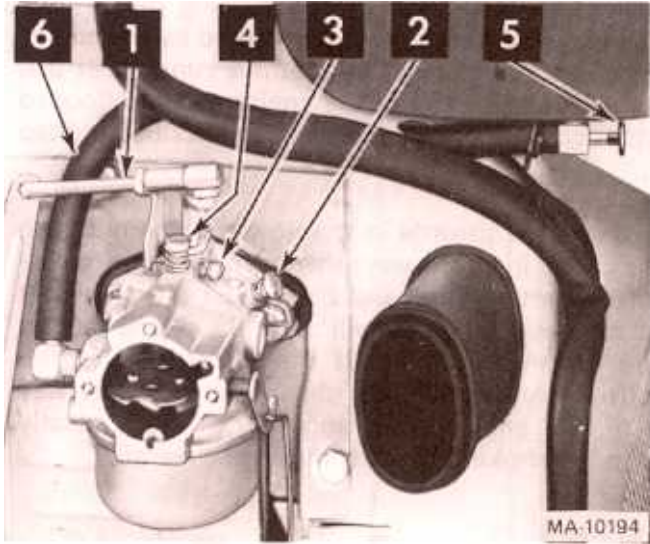

1. Governor control rod
2. Idle adjustment screw
3. Throttle stop screw
4. High speed adjustment screw
5. Fuel shut-off valve
6. Fuel line

International Cub Cadet 1000, 1200,
1250, 1450, and 1650 Tractors

Adjusting the High-Speed Adjustment Screw

Turn the high speed adjustment screw counterclockwise approximately two turns from the closed position and start the engine.

Be sure the choke is fully open (knob fully in) when adjusting.

After the engine has reached normal operating temperature, place the throttle lever in the fast position and turn the high speed adjustment screw clockwise to the leanest mixture that will allow satisfactory acceleration and steady governor operation. Then, turn counterclockwise to the richest mixture that allows satisfactory operation. The difference between the rich and lean points is about 1/2 turn. Set the mixture to the rich end of this range.

If the engine misses and backfires under load, the high speed mixture is too lean. The high speed adjustment screw must be turned counterclockwise 1/8 turn at a time until the condition is corrected.

If the engine shows a sooty exhaust and is sluggish under load, the high speed mixture is too rich. The high speed adjustment screw must be turned clockwise 1/8 turn at a time until the condition is corrected.

Adjusting the Idle Adjustment Screw

After the high speed adjustment screw is adjusted, it may be necessary to readjust the idle adjustment screw as each affects the other.

Close the idle adjustment screw to its seat by turning it clockwise; then open it one turn. Start the engine and operate it at fast idling speed (without any load) until thoroughly warm.

While the engine is running at fast idle speed, it is advisable to screw in the throttle stop screw a few turns to keep the engine from stopping when the throttle lever is moved to the fully retarded "SLOW" position. The engine will then be idling at a fairly high speed and the throttle stop screw can be backed out a little at a time until the desired idle speed is obtained (1800 RPM).

If the engine misses or rolls while backing out the throttle stop screw, the idle adjustment screw may be adjusted in or out until the engine operates smoothly. Speed up the engine for a few seconds; then recheck the idle adjustment. A slight adjustment in or out will give the smoothest idle.

 **CAUTION!** Carbon monoxide fumes can be fatal! Do not make any adjustments to the carburetor in a confined area such as a storage building. Move the tractor outside into the air.

DRIVING THE TRACTOR

PREPARING THE TRACTOR FOR EACH DAY'S WORK

Check the crankcase oil level and add new oil if necessary. See pages 30 and 31.

Clean the air cleaner element if necessary. See page 19.

Inspect the tires for general condition. See page 22.

ADJUSTING THE SEAT

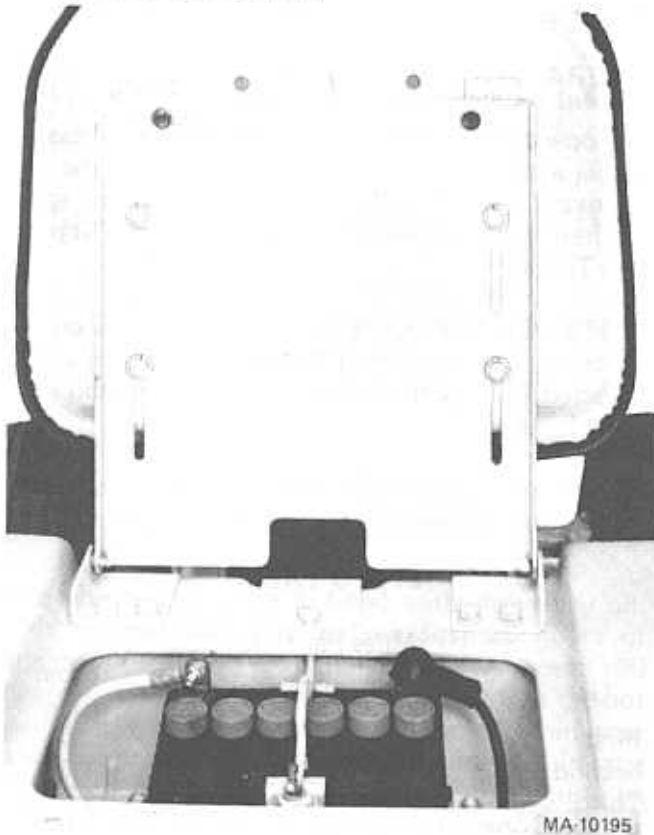

Before starting the tractor, adjust the seat to the most comfortable driving position. Tilt the seat forward over the steering wheel, loosen the four cap screws in the seat support, and slide the seat assembly forward or rearward to the position which is most comfortable for the operator.

Retighten the cap screws after the seat is adjusted.

NOTE: The battery is located in a well under the operator's seat for ease in servicing or replacement when necessary.

CLUTCH AND BRAKE PEDAL

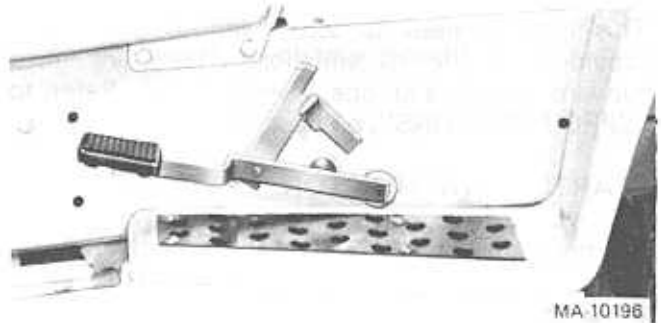

Brake pedal lock in the engaged position.

CAUTION! To prevent injury, always turn ignition "OFF", depress the brake pedal, and set the brake pedal lock before working on the machine. Disengage all implements and shift the transmission into neutral.

LOCKING THE BRAKE

Always lock the brake when the tractor is parked on a grade. To lock the brake, press down on the pedal; then place the brake pedal lock in the engaged position. To disengage the lock, press down on the pedal, lift the lock up and place it in the disengaged position.

CAUTION! On models 1250, 1450, and 1650 the hydrostatic transmission will not hold the tractor on a hill. In a short period of time (depending on the hill) the oil will drain from the transmission and allow the tractor to roll down hill. To avoid an accident and/or possible injury, lock the brake.

INTERNATIONAL CUB CADET 1000 AND 1200 TRACTORS

CLUTCH-BRAKE PEDAL

The combination clutch-brake pedal is used to disengage the engine from the transmission when shifting gears and to actuate the brake to stop the tractor. The pedal must be pressed all the way down to activate the safety starting switch when starting the engine. To disengage the clutch, and apply the brake, press the pedal all the way down.

DRIVING THE TRACTOR

INTERNATIONAL CUB CADET 1000 AND 1200 TRACTORS – Continued

GEARSHIFT LEVER

This lever is used to select various gear ratios provided in the transmission. There are three forward speeds and one reverse speed. Refer to "SPECIFICATIONS", on page 38.

STARTING THE TRACTOR

Disengage the clutch by pressing the clutch pedal all the way down, and release the brake lock. Move the gearshift lever to the desired speed.



CAUTION! To avoid the possibility of an upset, always engage the clutch slowly, especially on steep slopes. Avoid quick starts, stops.

Start the tractor in motion by slowly releasing the clutch pedal and moving the throttle lever to the position where the engine operates best for the load to be handled.

NOTE: When using power take-off operated equipment, best performance is achieved with the throttle lever in the "Fast" position.

NOTE: Do not shift gears while the engine clutch is engaged or while the tractor is in motion.

NOTE: Do not rest your foot on the pedal while driving the tractor, as this will result in excessive clutch lining wear.

Always be sure the rear wheels are free to turn. Under any adverse conditions, do not attempt to free the tractor by speeding up the engine and suddenly engaging the clutch. Try backing out instead of going forward.



CAUTION! Do not leave the seat of the tractor without disengaging the brake pedal and setting the brake lock. If leaving the tractor unattended, also turn the ignition key off and remove the key.

STOPPING THE TRACTOR

Disengage the clutch by pressing the pedal all the way down. Move the gearshift lever to the "N"

position. Before dismounting always lock the pedal, disengage the power take-off, and turn the ignition "OFF".

CREEPER SHIFT LEVER

The creeper drive (optional) provides a slower speed in each respective gear, by a four-to-one reduction in speed from direct drive. When creeper shift lever is all the way forward, it is in direct drive, or all the way rearward, it is in creeper drive.

OPERATING THE CREEPER DRIVE

To operate the tractor in creeper drive, depress the pedal and move the creeper shift lever all the way rearward. Then select the transmission speed desired and proceed as instructed under "Starting the Tractor".

NOTE: Do not use a mid-point position on the creeper drive as neutral. Neutral position must be selected only with the standard transmission gearshift lever.

The following table shows speeds available in each of the three forward gears and reverse gear.

SPEED TABLE

Gear	Miles Per Hour	
	Direct Drive	Creeper Drive
First	2.3	.6
Second	3.5	1.0
Third	6.9	1.7
Reverse	2.5	.6

INTERNATIONAL CUB CADET 1250, 1450, AND 1650 TRACTORS

BRAKE PEDAL

Brake pedal must be pressed all the way down to activate the safety starting switch. When brake pedal is in the depressed position it automatically moves the speed control lever to the "N" position.

The tractor can be stopped either by pressing the pedal all the way down, or placing the speed control lever in the "N" position.

DRIVING THE TRACTOR

INTERNATIONAL CUB CADET 1250, 1450, AND 1650 TRACTORS – Continued

NOTE: Do not rest your foot on the brake pedal while driving the tractor as this would cause the speed control lever to return to the “N” position.

SPEED CONTROL LEVER

This lever is used to select any speed from a standstill “N” position to eight miles per hour in the forward direction and to four miles per hour in the reverse direction.

Moving the speed control lever forward provides increased forward speed, and moving the lever rearward provides the reverse speeds.

SPEED CONTROL LEVER STOP

An adjustable speed control lever stop is provided to allow the operator to return to a predetermined speed.

Do not bypass the speed control lever stop to obtain a higher tractor speed. If a higher speed is desired, reset the stop.

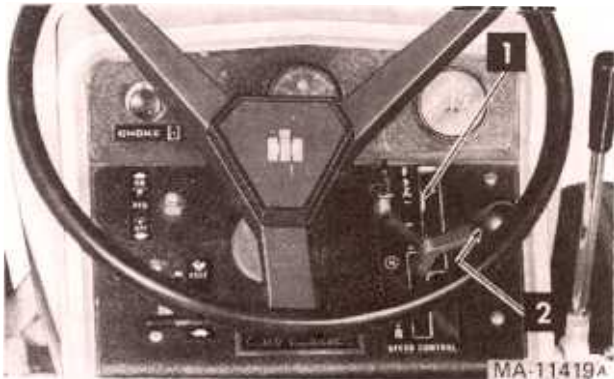

1. Speed control lever stop
2. Speed control lever

NOTE: On tractors with a rotary tiller the following instructions are required.

1. Engage the Power Take-Off clutch, and move the throttle to “Fast”.
2. Lower the rotary tiller to the desired cutting depth.

3. Move the speed control lever to start forward motion. **NOTE:** In rotary tilling application, the tractor is used to hold the rotary tiller back rather than to pull the unit as in plowing or mowing.

4. Move the speed control lever back to a position to maintain proper mulching of the soil.

5. With a hydrostatic drive, it may be necessary to vary the speed control lever as the soil conditions vary. With a gear driven tractor, under similar conditions it may be necessary to declutch or to use the brake.

RELEASE LEVER

Some tractors are equipped with a release lever on the right side of the frame near the cam stop. To push or move the tractor for a short distance, the release lever (if so equipped) must be held in the (UP) position and the speed control lever (on all models) must be in the “N” position.

NOTE: Never operate engine with release lever in (UP) position. Towing or pushing the tractor for more than a few feet may result in transmission damage.

STARTING THE TRACTOR

1. Depress the brake pedal, release the brake lock, and let the brake pedal up. Move the throttle lever to the position where the engine operates best for the load to be handled.

2. Start the tractor in motion by moving the speed control lever slowly forward or rearward as described above.

STOPPING THE TRACTOR

Move the speed control lever to the “N” position or use the brake. Before dismounting always lock the brake pedal and turn the ignition “OFF”. Also, disengage the power take-off clutch lever.



CAUTION! To prevent injury or an accident, do not carry passengers or give rides. Keep children, pets, and bystanders out of the area.

EQUIPMENT LIFT HANDLE

The lift handle is used to lift or lower equipment used with the tractor. The equipment can be set in multiple positions by depressing the button on the top of the handle and releasing it when the desired position is reached.

HEIGHT ADJUSTMENT

If a single implement height is normally used, the handle may be adjusted to locate the desired position by use of the cam stop.

With lift handle in desired implement height position, release cam by turning locking knob counterclockwise. Turn cam until it contacts tang.

Lock cam into this position by turning knob clockwise.

If free handle travel between cam stop and fully raised position is desired (Float Position), depress the release button on top of the handle, press in the lock button located at the front of the handle and release the top button.

NOTE: To disengage the lift handle from the float position, pull lift handle back slightly and depress top button.

NOTE: Refer to the equipment manual for proper hitching instructions.

HITCHING EQUIPMENT TO THE TRACTOR

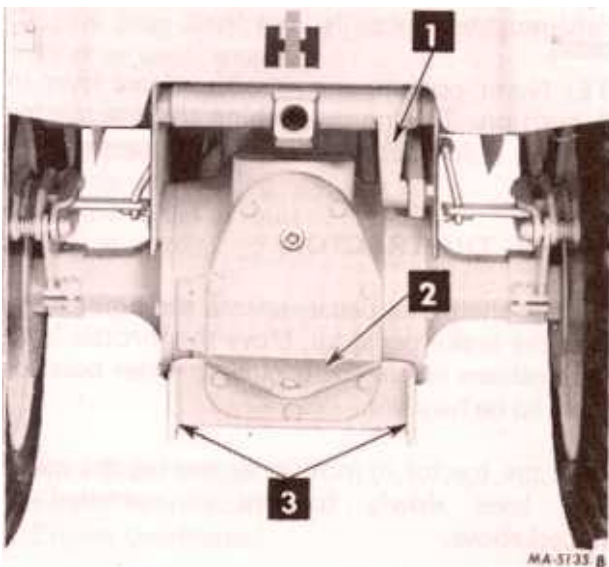

1. Lift lever
2. Drawbar
3. Lower mounting points

Drawbar and three-point hitch.

DRAWBAR

Drawbar equipment must be hitched to the tractor only at the hitch hole in the drawbar.

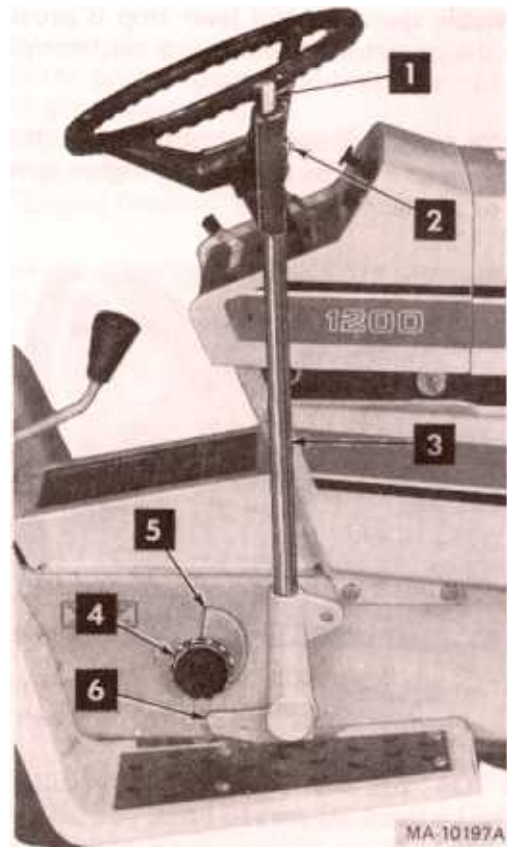

- | | |
|-------------------|------------------|
| 1. Release button | 4. Cam lock knob |
| 2. Lock button | 5. Cam stop |
| 3. Lift handle | 6. Tang |

Adjustable stop limiting handle travel.

HITCHING EQUIPMENT TO THE TRACTOR

THREE-POINT HITCH

When the tractor has a three-point hitch, equipment adaptable to this hitch is raised and lowered with the lift handle or power lift control. The lift handle can be set to hold the equipment at various positions by use of the notches in the lift handle quadrant or cam stop. The lower mounting bracket at the rear has three holes which are used for additional adjustment.



CAUTION! To prevent an accident disengage power to any attachment when transporting or not in use.

NOTE: Refer to the equipment manual for proper hitching instructions.

REAR POWER TAKE-OFF

International Cub Cadet 1000 and 1200 Tractors

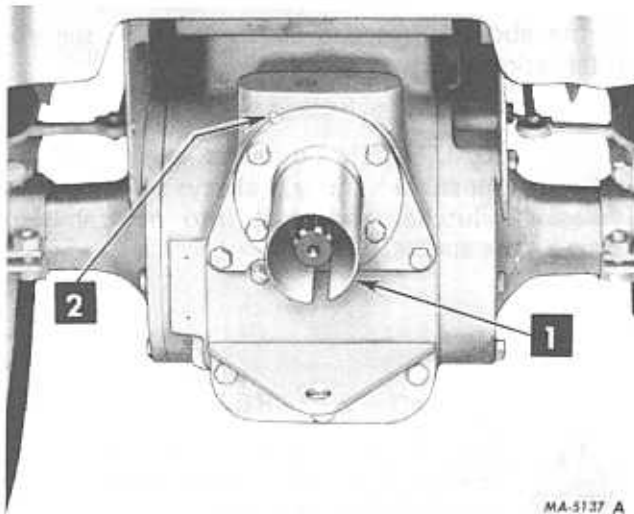

1. Power take-off guard
2. Grease fitting

If your tractor is equipped with a rear power take-off, the following instructions should be carefully studied and followed.

The rear power take-off is started and stopped by the same engine clutch as the tractor. Be sure to disengage the engine clutch before moving the power take-off shifter lever.



CAUTION! This shifter lever should always be in the disengaged (rearward) position when the power take-off is not in use. Always cover the power take-off exposed shaft with the guard when the power take-off is not being used.

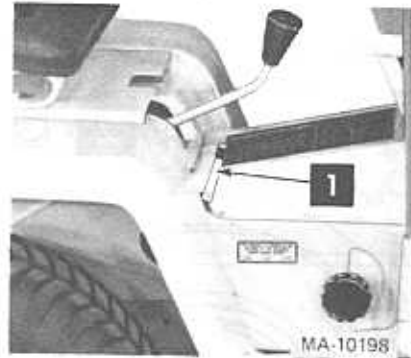

1. Shifter lever

OPERATING THE REAR POWER TAKE-OFF WITH THE TRACTOR STANDING STILL

1. Move throttle lever back to "SLOW" speed.
2. Depress the pedal and move the transmission gearshift lever to the neutral position.
3. Move the shifter lever forward to the engaged position.
4. Move the throttle lever forward to the "FAST" position and slowly release the pedal.

OPERATING THE REAR POWER TAKE-OFF WITH TRACTOR IN MOTION

Follow steps 1 thru 3 outlined above. Keep the pedal depressed, move the transmission gearshift lever to the speed desired and advance the throttle lever. Slowly release the clutch pedal. This will cause the tractor to move and the power take-off to operate.

FRONT POWER TAKE-OFF

OPERATING THE FRONT POWER TAKE-OFF CLUTCH

The front power take-off clutch is an electric clutch operated by a toggle switch on the left side of the instrument panel.

1. Move the throttle lever back to the medium or "slow" position.
2. Flip the toggle switch on to the "ON" position.
3. Advance throttle to operating speed (full speed).

ADJUSTING THE POWER TAKE-OFF CLUTCH

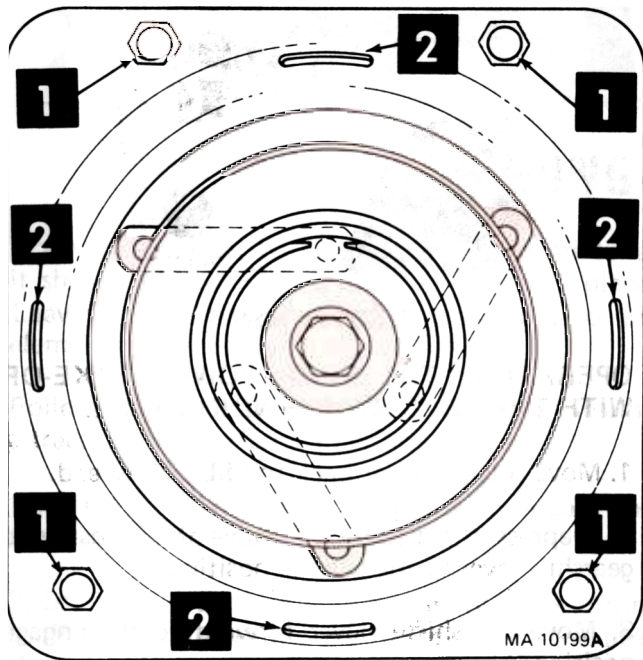

1. Self-locking nuts (4)
2. Feeler gauge openings (4)

The clutch is factory adjusted and should not require further adjustment under normal operating conditions. However, if the clutch fails to operate properly check as follows:

Check fuse on pedestal.

Using a feeler gauge, check the air gap! Insert the feeler gauge into one of the access slots (Ref. 2 in illustration) and between the clutch plates. If the air gap is not .015/.010 inches, adjust the self-locking nuts (Ref. 1) to obtain the proper clearance. Repeat the operation in all four slots.

If the above procedure does not work, see your International Harvester dealer.



CAUTION! To avoid an accident or possible injury, always disengage all clutches and shift into neutral before starting the engine.



CAUTION! To avoid possible injury, always disengage all clutches, shift the transmission into neutral, depress the brake, set the brake pedal lock and turn the ignition "OFF" before working on the machine.

ELECTRIC LIFT

The electric lift is a self-contained unit designed to provide power with fingertip control for raising or lowering mounted equipment.

The electric lift is available on all Cub Cadet Tractors except the Models 1450 and 1650 which is equipped with a hydraulic lift as standard.

ELECTRIC LIFT

OPERATING INSTRUCTIONS

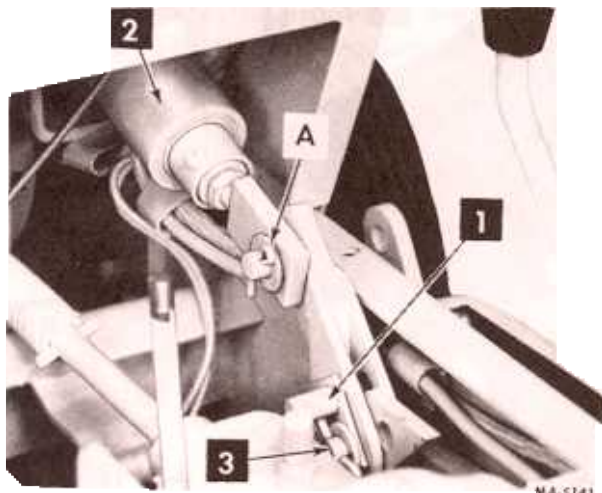

1. Float lockout pin (optional)
2. Electric lift unit
3. Pivot pin

The electric lift is operated by a control switch on the right-hand side of the instrument panel. To raise the implement push upward on control switch until desired height is reached, then release the switch. Switch will return to the center or neutral position. Equipment will stay in a given position when you release the switch. To lower equipment push down on the control switch. Switch will again return to the central or neutral position when you release it.

NOTE: Always operate electric lift with tractor engine running. Operation of electric lift off the battery will cause premature battery failure.

NOTE: Whenever raising or lowering equipment release control switch when equipment has reached a fully raised or lower position. Holding control switch will cause protective switch to open the circuit. Lift will function after waiting 30 seconds.

Equipment is normally operated in a "Float" position (implement free to move upward) with lock pin (optional) positioned as shown. Cam stop on the outside of the frame may be adjusted as described on page 14 to allow implement to return to a single preset height.

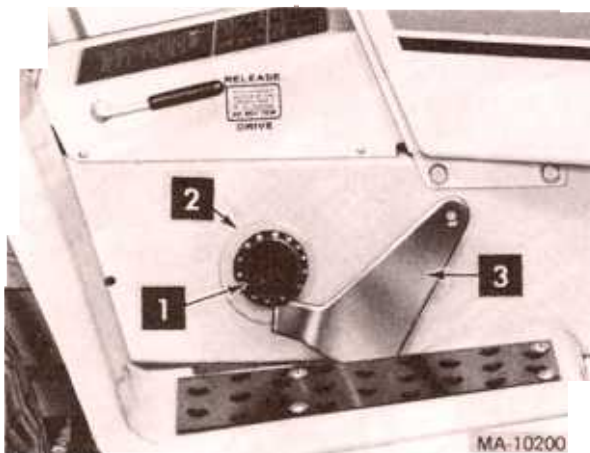

1. Locking knob
2. Cam stop
3. Rockshaft arm

To operate equipment in a fixed "Locked" position, where down pressure of implement is required (that is blade work); remove frame cover and remove cotter pin in pivot. Reverse lock pin (optional) and insert into pre-aligned holes in clevis and lower portion of rockshaft arm. Replace washer and cotter pin.



CAUTION! To avoid injury, always stop the engine and set the brake pedal in the locked position before making any adjustments to the machine.

NOTE: Remove or position cam stop on side of frame for full travel of rockshaft before locking rockshaft arms as described above.

NOTE: To avoid possible damage, as soon as the operation requiring "Down Pressure" is completed, immediately return the float lockout pin to the "Free to Float" position.

Refer to equipment manual for proper mounting instructions.

NOTE: Periodically lubricate pin "A" with a few drops of engine oil.

HYDRAULIC LIFT

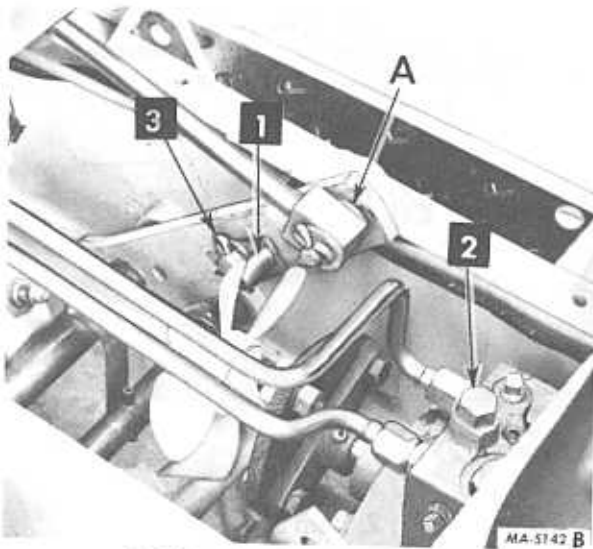

1. Float lockout pin (optional)
2. Hydrostatic drive unit
3. Cotter pin

The hydraulic lift is ready to operate when the engine is running.

OPERATING INSTRUCTIONS

The hydraulic control lever is spring loaded. To raise the equipment move the lever back, toward the tractor seat. To lower the equipment move the lever forward, as shown.

Equipment is normally operated in a "Float" position (implement free to move upward) with the lock pin (optional) positioned as shown.

The cam stop may be adjusted as described on page 14 to allow the implement to return to a single preset height.

To operate equipment in a fixed "Locked" position, where down pressure of the implement is required (that is blade work), remove frame cover and remove cotter pin in pivot pin. Reverse lock pin (optional) and insert into pre-aligned holes in clevis and lower portion of rockshaft arm. Replace washer and cotter pin.

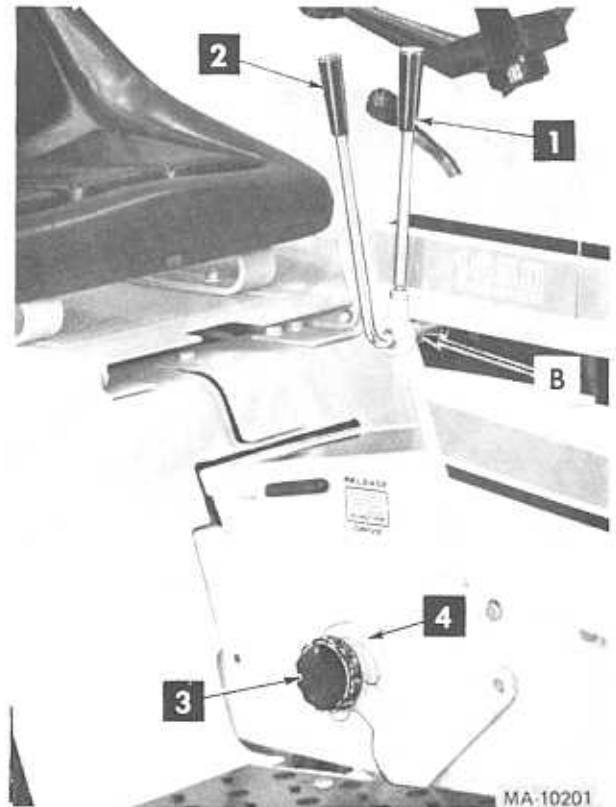

1. Hydraulic lift control lever
2. Front hydraulic outlet control lever *
3. Locking knob
4. Cam stop

NOTE: Remove or position cam stop on side of frame for full travel of rockshaft before locking rockshaft arm as previously described.

NOTE: To avoid possible damage, as soon as the operation requiring "Down Pressure" is completed, immediately return the float lockout pin to the "Free to Float" position.

Front Hydraulic Outlet Control Lever
* Optional Equipment

This optional equipment feature provides for "on-the-go" angling of a front mounted blade.

Refer to equipment manual for proper mounting instructions.

NOTE: Periodically lubricate pin "A" and bushing "B" with a few drops of engine oil in both locations.

ENGINE COOLING AND AIR CLEANER

ENGINE COOLING

This tractor has an air cooled engine. Air must be able to circulate freely around the engine, through the screen, shroud, and over the fins of the cylinder head and cylinder block. Keep these areas free of accumulated dirt and trash or engine will overheat and result in damaged moving parts. Periodically clean the inside of the side panels and grill screen for adequate cooling.

NOTE: These machines are designed to cool properly with the engine side panels in place. Operating the machine without panels in place may result in inadequate cooling.

DRY TYPE AIR CLEANER

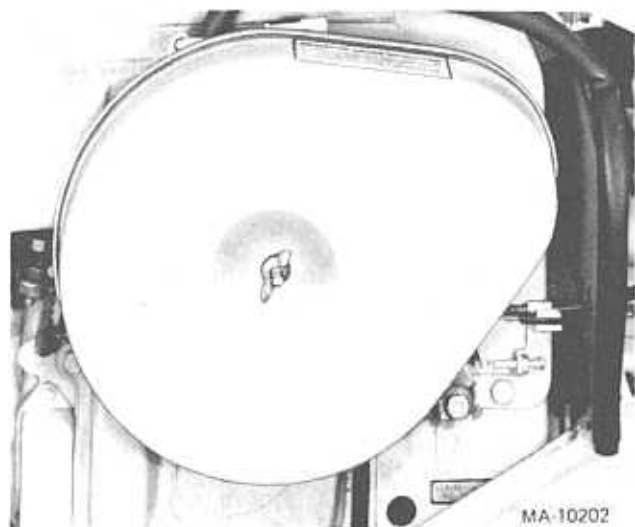

All engine air used for combustion is filtered by a dry type air cleaner to assure long engine life.

NOTE: Left engine side panel must be removed to have access to the air cleaner.

Service the air cleaner element when a loss of power is noticeable. Discard used element and replace with a new one at least once a year.

Cleaning the element: The left hand side panel must be removed to obtain access to the air cleaner housing. To clean the element, remove the wing nut and air cleaner cover, remove the element from the back plate. Take care to avoid dislodging accumulated dust on the element into the carburetor inlet. Use compressed air to blow the element clean. Direct air hose from the inside of the element. Do not water wash or use solvents to clean elements. Use care when handling the element; it will not withstand tapping or knocking against solid objects as an alternative cleaning method.

Replacing the element: If the perforated metal sleeve is dented or the sealing surface damaged, discard and install a new element. When replacing an element, always examine the air cleaner backplate and be sure it is securely tightened to the carburetor. Install a new backplate if the old one is bent or cracked.

Be sure the element fits around the ledge on the backplate before installing air cleaner cover. Replace the cover (rubber gasket must be in place) and tighten the wing nut securely. Do not use plier — finger tight is adequate. Reinstall the side panel.

Properly cleaned and installed air cleaner elements are the best guarantee to continued long and satisfactory engine life.

ELECTRICAL SYSTEM

The twelve-volt electrical system consists principally of a rectifier, alternator, starting motor, and a twelve-volt battery.

All connections must be clean and securely fastened.

IGNITION SWITCH

Turn the key clockwise to turn on the ignition. A further turn actuates the starting motor. The key cannot be removed when in the "ON" position.

NOTE: When the engine is not operating, the key must be turned to the "OFF" position to prevent battery discharge.

SAFETY STARTING SWITCH

The safety starting switches activated by the clutch-brake pedal and the power take-off clutch switch serve to prevent starting the engine accidentally.

ELECTRICAL SYSTEM

CHARGE INDICATOR

This instrument indicates whether the alternator is charging or the battery is discharging. If it shows discharge continuously, investigate the cause to avoid completely discharging the battery and possible damage to the charging circuit.

HOUR METER

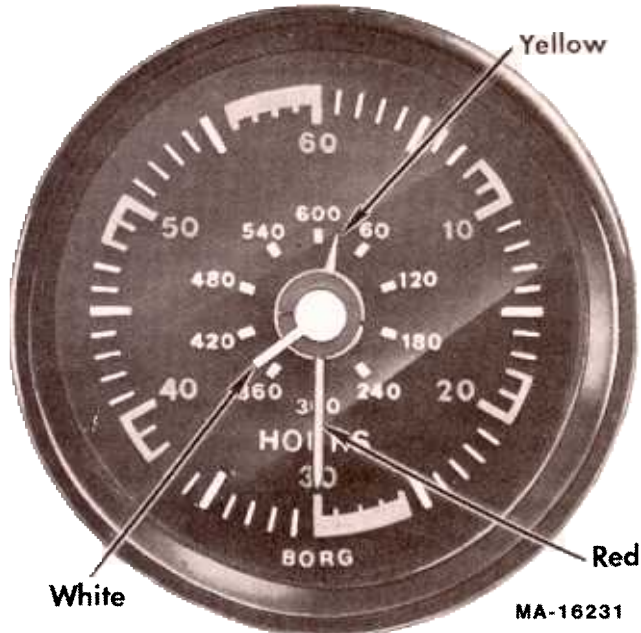

The International Cub Cadet Tractors are equipped with an hour meter which is located on the instrument panel. It indicates the actual hours of engine operation, enabling the operator to determine without guesswork, when lubrication, change of oil or periodic inspections are necessary. It also provides a means of computing cost of specific jobs. The hour meter operates whenever the engine is running or the ignition key is in the "ON" position.

The red dial indicates the number of hours from 0 to 60. The yellow dial indicates the total hours of operation up to 600. For one revolution of the red dial the yellow dial moves 1/10 of a revolution. The white dial indicates that the hourmeter is operating.

LIGHTS

Lights are optional on all models except the Models 1450 and 1650.

The headlights are sealed-beam units. Refer to "SPECIFICATIONS" when replacement is necessary.

To replace the taillight lamp, remove the lens from the taillight and replace. Refer to "SPECIFICATIONS".

SPARK PLUG

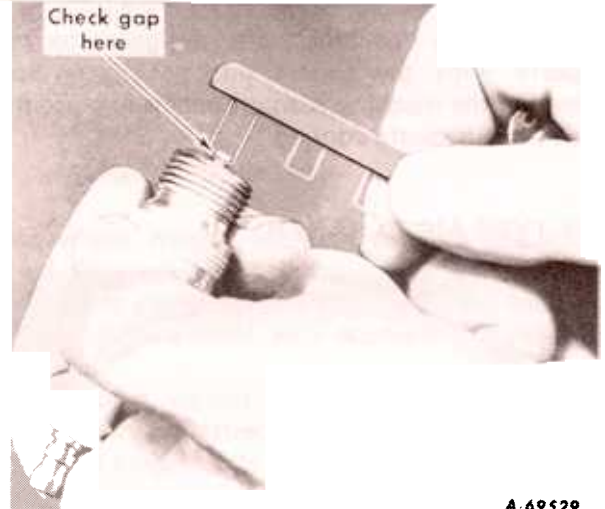

Checking the spark plug gap.
Set gap at .025-inch.

A-69529

NOTE: Remove all dirt from around the spark plug before removing.

Remove the spark plug, always using a spark plug wrench, after every 100 hours of operation to check the gap.



CAUTION! To avoid possible injury, be sure engine is off and cool before making any adjustments or repairs.

Replace a defective plug with a new plug. See your International Harvester dealer for the correct replacement plug.

FUSES (Electric Lighting and Electric Power Take-Off Clutch)

Always use the same capacity fuse for replacement. Refer to "Specifications". If the lights fail or the electric clutch does not engage, check the appropriate fuse.

ELECTRICAL SYSTEM

FUSE - Continued

NOTE: There are two fuses adjacent to the lighting switch on the tractor pedestal (left side). The lower fuse is for the lights; the upper fuse is for the electric clutch.

To install a new fuse, press in on the fuse housing cap and turn counterclockwise to remove it from the fuse housing. Remove the old fuse and replace it with a new one. Then reassemble the cap to the housing.

Before working on any part of the electrical system, disconnect the battery ground cable at the battery negative (-) terminal. Do not reconnect this cable until all work has been completed. This will prevent shorting and damage to any of the electrical units. Examine the electrical cables occasionally to be sure they are not being frayed by contact with adjacent parts.

When replacing a battery, make certain the ground cable is connected to the negative (-) terminal on the battery. Be sure the rubber boot is properly positioned over the positive (+) terminal on the battery. **NOTE:** Both cables must be assembled with the nuts to the inside of the terminals to prevent shorting against fender well.

Cleaning and Servicing the Battery

Occasionally remove the battery cables and brighten the terminal contact surfaces with wire wool, and reassemble them. Apply a light coat of vaseline or chassis lubricant. Be sure the terminals are clamped tightly and that the battery is fastened securely in the battery box. Replace unserviceable cable. Keep the vent holes in the battery filler caps open.

Keeping the battery fully charged not only adds to its life but makes it available for instant use when needed.

Liquid Level

Check the battery at least once a month for electrolyte level.

The electrolyte (acid and water) in each cell should be at ring level at all times to prevent battery failure. When the electrolyte is below this level, add pure, distilled water.

Acid or electrolyte should never be added except by a skilled battery man. Under no circumstances add any special battery "dopes", solutions or powders.



CAUTION! If the tractor is to be tipped up or on its side remove the batteries to avoid spilling the electrolyte. Battery electrolyte is poisonous and can be injurious to eyes, skin, and clothing. If electrolyte is spilled, flush immediately with water, followed by a solution of one part baking soda to four parts water.

Connecting Booster Batteries

When required, a booster 12-volt battery may be connected in parallel with the 12-volt system on International Cub Cadet Tractors.



CAUTION! Gas discharged by batteries is explosive. Avoid sparks near the batteries.

NOTE: All circuits must be turned "off". Electrical system is NEGATIVE (-) grounded only. Reversed polarity will result in permanent damage to components of the electrical system.

The first jumper cable must connect the positive (+) terminal of the booster battery and the positive terminal of the battery on the tractor.

The second jumper cable must first be connected to the negative (-) terminal of the booster battery; and then to a point on the frame of the tractor, away from the battery, having a good ground, so no spark occurs near the battery.

For dependable battery service, see your International Harvester dealer.

PNEUMATIC TIRES

6–12 rear tires are standard equipment on the International Cub Cadet 1000 Tractor.

23 x 8.50–12 high floatation tires are standard equipment on the International Cub Cadet 1200, 1250, and 1450 Tractors. They are also available as optional equipment when ordered for the International Cub Cadet 1000 Tractor.

23 x 10.5-12 tires are standard on the International Cub Cadet 1650 Tractor.

The high floatation tires provide maximum mobility in sand, snow, and soft soil conditions. The reduced ground pressure and low inflation provides maximum protection for turf, soil and crops.

CARE OF TIRES

Avoid stumps, stones, deep ruts, curbs, and other hazards. Cuts in tires should be repaired immediately as neglect decreases the tire life.

Keep tires free from oil and grease as both destroy rubber.

After using the tractor for spraying use water to remove any chemicals that may be on the tires.

INFLATION

Keep the pneumatic tires properly inflated. Over-inflation will cause operator discomfort. Under-inflation will cause short tire life.

Always see that the tire valve caps are in place and tightened securely to prevent loss of air and protect the valve core and stem.

OPERATING PRESSURE FOR TIRES

Inflate the front and rear tires for normal or heavy load operations as shown in the following table.

Tire Size	Pounds per square inch
Front Tires	
4.80/4.00-8	12
16 x 6.50-8	12
Rear Tires 6-12	12
23 x 8.50-12	12
23 x 10.50-12	12

REAR WHEEL WEIGHTS

Rear wheel weights increase traction and reduce wheel slippage. The weights weigh approximately 26 pounds each. They are attached to each rear wheel with two bolts, lock washers, and hex nuts.

If additional weight is desired, a second set of weights can be attached to each first weight by using two longer bolts.

MOUNTING TIRES ON THE RIM

After mounting a new or old tire on the rim, inflate it to 20 pounds pressure to seat the tire bead on the rim flange. Then deflate the tire to the correct operating pressure.

TIRE CHAINS

Tire chains will provide additional traction for wet ground conditions, when plowing snow, or pulling heavy loads. Rear wheel weights are recommended when using chains.

OVERLOADING

Do not overload the tractor tires by mounting equipment on the tractor which exceeds the load capacity of the size of the tires on the tractor.

FRONT WHEELS

FRONT QUICK ATTACHING LATCH

This latch is used for front and center mounted equipment. Refer to the equipment manual for proper instructions.

FRONT WHEEL TOE-IN

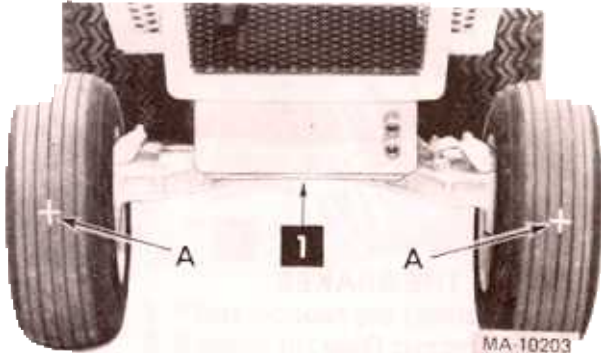

1. Front quick attaching latch

Front wheel adjustments.

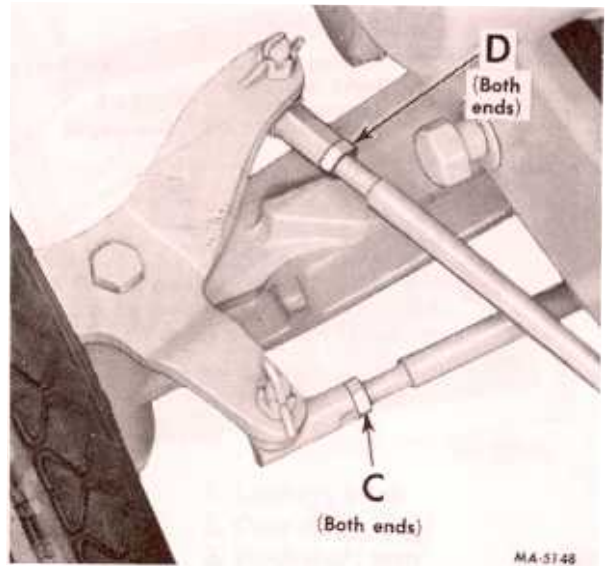

Tie rod and drag link ball joints.

The front wheel toe-in dimension is approximately 1/8-inch closer in front than in the rear. To measure for proper toe-in, make a chalk mark on the centerline of each tire the same height from the ground as the front wheel hubs. Measure the distance between the marks "A", then rotate the tires so that the marks are toward the rear of the tractor, the same height from the ground as they were in front. The dimension should be approximately 1/8-inch larger at the rear. See "B".

To adjust the toe-in remove one ball joint, loosen the lock nut "C" at the ball joint and turn the tie rod ball joint in or out as required.

TURNING RADIUS

The front wheel should have an equal angle for left and right turns. If adjustment is necessary, remove ball joint and loosen lock nut "D", turn the drag link ball joint clockwise or counterclockwise as required.



CAUTION! Be sure all parts are re-assembled tight with cotter pins in place and spread.

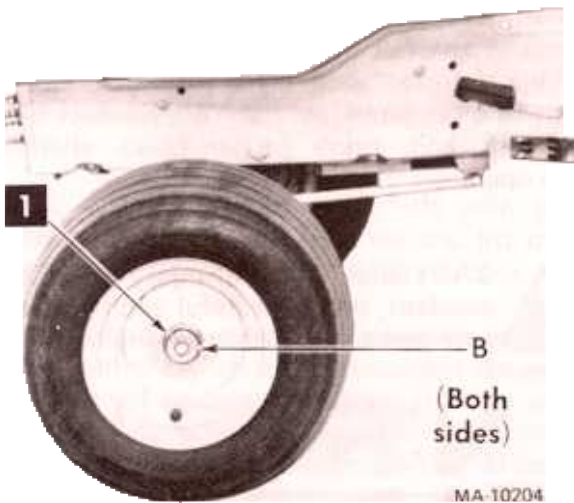

1. Wheel hub

Front wheel adjustments.

CLUTCH-BRAKE

International Cub Cadet 1000 and 1200 Tractors

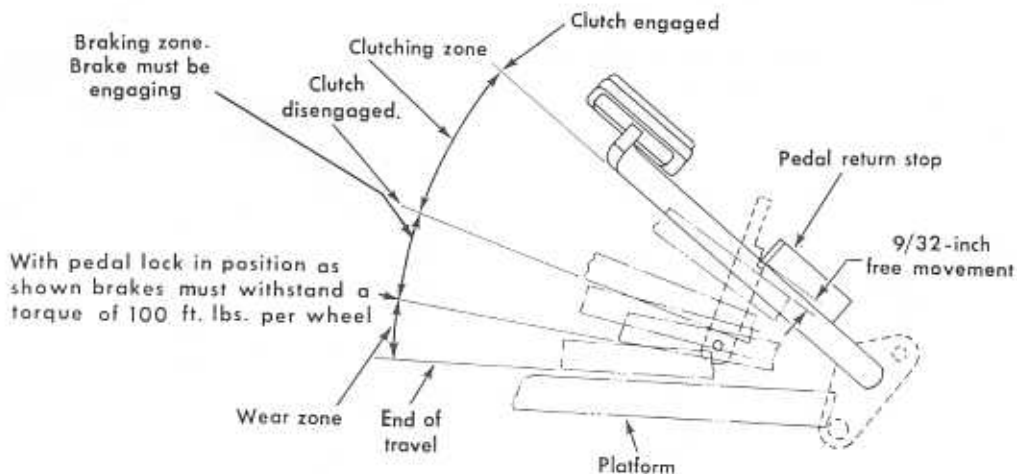

ADJUSTING THE CLUTCH

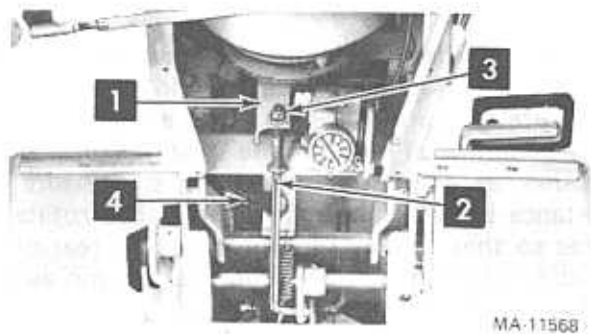

1. Clutch release lever
2. Clutch release rod
3. Adjusting nut
4. Safety starting switch

It is important that a clearance of .050-inch be maintained between the clutch release lever and the clutch release bearing. In order to maintain this clearance, the pedal should have a free movement of approximately 9/32-inch. This measurement is taken at the point of contact of the pedal arm with the front edge of the pedal return stop.

The clutch pedal adjustments are set at the factory and should not require frequent attention unless the linkage has been disturbed or when the pedal movement becomes less than 9/32-inch. When it is necessary to adjust the clutch, turn the adjusting nut (No. 3) on the clutch release rod in or out as required to get the proper measurements.

ADJUSTING THE BRAKES

Gear Drive Tractors Only

To adjust the brake, first raise one of the rear tires off the ground and loosen jam nut "B". Then, while rotating the tire, turn brake lever adjusting screw "C" in until brake just begins to drag; then tighten jam nut "B" while holding the adjusting screw. This adjustment should be made with the brake pedal in the up position.

If brake drags after tightening jam nut "B", loosen the jam nut and back off adjusting screw "C" slightly and retighten jam nut "B". Recheck brake adjustment and insure proper brake operation before operating tractor.

 **CAUTION!** To avoid injury or possible accident, be very careful and take necessary precautions when raising tractor off the ground.

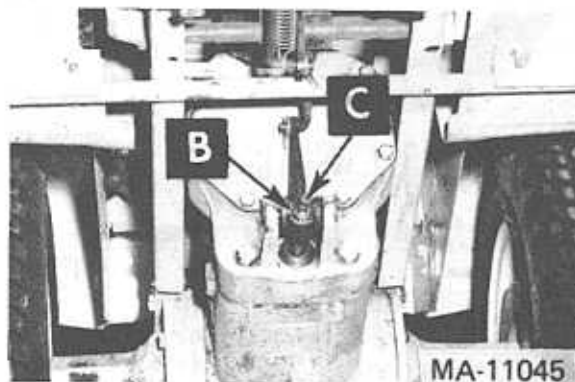

BRAKES

International Cub Cadet 1250, 1450, and 1650 Tractors

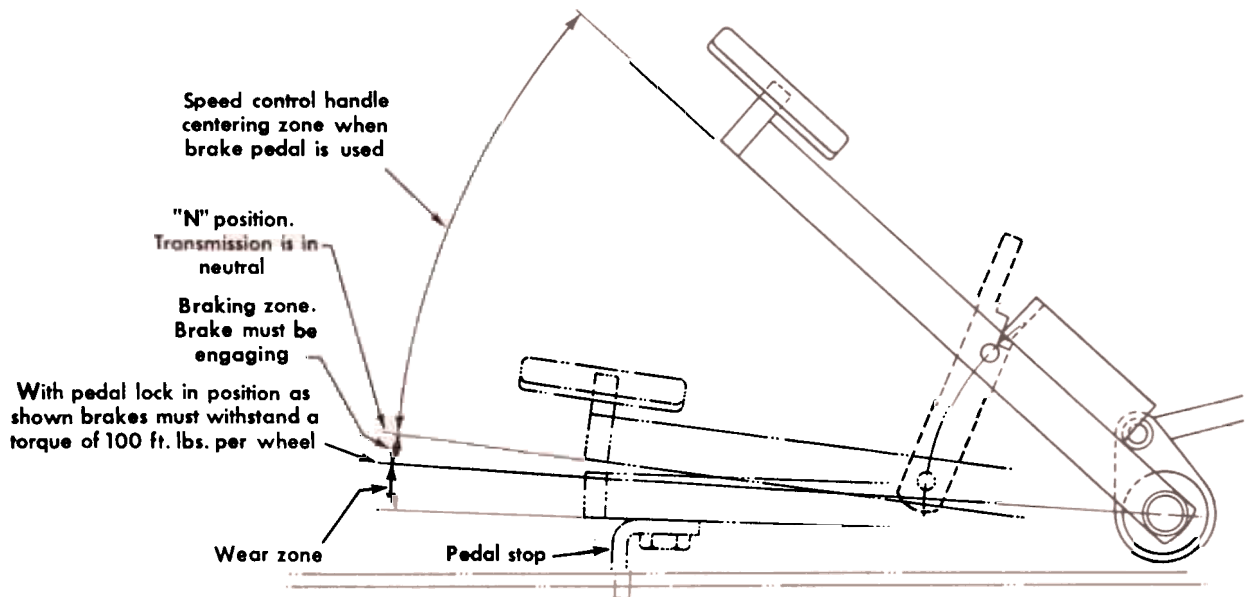

Brake adjustments.

ADJUSTING THE BRAKES – Continued

Hydrostatic Drive Tractors With Disc Brakes Only

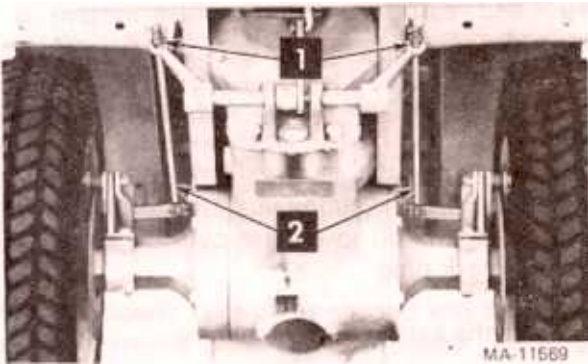

Adjust to 100 ft. lbs. per wheel as shown in illustration. Block the front wheels securely and raise the tractor so the rear wheels are off the ground.



CAUTION! To avoid injury, always stop the engine and set the brake pedal in the locked position before making any adjustments to the machine.

The disc brakes should start to engage when the pedal is pressed down to within a maximum of 1-3/16-inches and a minimum of 3/4-inch above the pedal stop.

The brake is engaged when pedal arm is at least 3/4-inch above pedal stop.

NOTE: The brakes must not engage before pedal is within the maximum distance of 1-3/16-inches.

With rear wheels off the ground and brake pedal in the locked position, the brake settings should be equalized as follows:

Disconnect left brake rod at the pinned end, rotate the right wheel by hand and adjust the jam nuts on the brake rod until the wheel brakes firmly. Then, disconnect the right brake rod at the pinned end and reconnect the left brake rod. Turn the left wheel by hand and adjust the jam nuts until the wheel brakes firmly. Reconnect the right rod.

BRAKES

International Cub Cadet 1250, 1450, and 1650 Tractors

ADJUSTING THE BRAKES Continued

 **CAUTION!** To avoid injury or possible accident, be very careful and take necessary precautions when raising tractor off the ground.

Hydrostatic Drive Tractors With Internal Brake

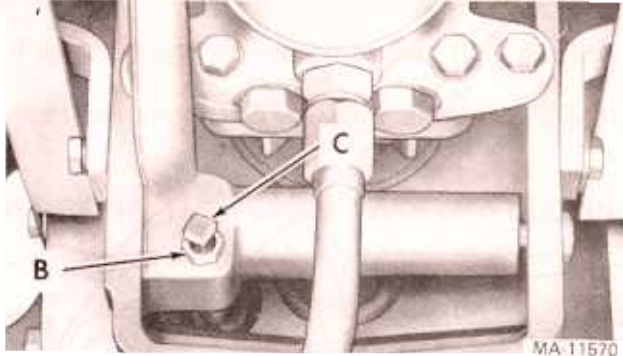

To adjust the brake, loosen jam nut "B". Next, tighten the brake lever adjusting screw "C" until finger tight (8 - 10-inch pounds). Tighten jam nut "B" while holding the adjusting screw.

If the brake drags after tightening jam nut "B", loosen the jam nut and back off adjusting screw "C" slightly and retighten jam nut "B". Recheck brake adjustment and insure proper brake operation before operating the tractor.

 **CAUTION!** Remember — A careful operator is the best insurance against an accident.

STORING THE TRACTOR

When your tractor is not to be used for some time, it should be stored in a dry and protected place. Leaving your tractor out-doors, exposed to the elements materially shortens its life.

Follow the procedure outlined below when storing a tractor for an extended period of time.

1. Wash or clean and completely lubricate the tractor. See the "Lubrication Guide".
2. Store the tractor so the tires are protected from sunlight. Before storing the tractor, clean the tires thoroughly. Jack up the tractor so the load is off the tires when it is to be out of service for a long period. If not jacked up, inflate the tires at regular intervals.

 **CAUTION!** If tractor is jacked up or placed on blocks, be sure it is done so it cannot be tipped over or fall on someone.

3. Run the engine long enough to thoroughly warm the oil in the crankcase and then drain the oil. Refill the crankcase with fresh oil as specified in the "Lubrication Table" and run the engine for about five minutes.

4. Drain the fuel tank and run the engine until the fuel is exhausted from the fuel system.

NOTE: Gum will eventually form in the fuel tank, line, and carburetor if the fuel system is not drained.

5. After the engine has cooled, remove the spark plug and pour two tablespoonsful of a rust inhibited oil such as Hy-Tran® or IH No. 1® engine oil into the cylinder. Crank engine slowly to distribute the oil over the cylinder walls. Then replace spark plug.

6. Clean the exterior of the engine.

7. Remove the battery and place it in a cool, dry place above (+32° F.). Check battery at least once a month for electrolyte level and amount of charge. See page 21.

8. On all gear driven International Cub Cadet Tractors press clutch and brake pedal all the way down and engage the brake pedal lock. This will prevent clutch lining from sticking to pressure plate.

STORING THE TRACTOR

REMOVING FROM STORAGE

1. Fill the fuel tank and be sure the grade of oil in the crankcase is according to the temperature range in the "Lubrication Table".
2. Install a fully charged battery and properly connect.
3. Start the engine and let it run slowly. Do not accelerate it rapidly or operate at high speed immediately after starting.



CAUTION! Keep doors wide open or release brake pedal lock and move the machine outside the storage room before engine is started to avoid the danger from exhaust gas.

4. Check air pressure in tires.

EXTRA EQUIPMENT AND ACCESSORIES

When you purchased your tractor, you probably had it completely equipped for your particular needs at the time. However, later you may wish to obtain some of the equipment or accessories shown below. These items and other allied equipment can be purchased from, and installed by, your International Harvester dealer.

The tractor is used for so many different types of work, and because it is called on to operate under so many different conditions, a variety of equipment is available to adapt it to the requirements of the user.

Type of Equipment	Models used on				
	1000	1200	1250	1450	1650
Creoper Drive	X	X	—	—	—
Dual Rear Wheels	X	X	X	X	X
Electric Lift	X	X	X	—	
Electric Lighting	X	X	X	—	
Float Lockout Pin	X	X	X	X	X
Implement Handle Helper Spring	X	X	X		
Rear Power Take-Off	X	X	—	—	—
Rear Wheel Weights	X	X	X	X	X
Three-Point Hitch	X	X	X	X	X
Tire Chains	X	X	X	X	X
Tractor Cover	X	X	X	X	X
Utility Box	X	X	X	X	X

TROUBLE SHOOTING

Possible Cause

Possible Remedy

HARD TO START

No gasoline in fuel tank or carburetor	Fill the tank with gasoline; open the fuel shut-off valve. Check the fuel line, and carburetor.
Fuel line or carburetor clogged	Clean the fuel line and carburetor with commercial carburetor cleaner.
Water in gasoline	Drain the fuel tank and carburetor. Use new fuel and dry the spark plug.
Choked improperly. Flooded engine	Follow the starting instructions.
Defective ignition or loose wiring	Check the wiring, spark plug, or breaker.
Defective battery	Check and service; See page 21 or replace.
Spark plug dirty or improper gap	Clean, adjust the gap to .025 inch, or replace the plug.

ENGINE OPERATES IRREGULARLY OR KNOCKS

Engine incorrectly timed	*
Spark plug dirty; wrong gap or wrong type	Clean, reset the gap, or replace.
Poor or weak spark	Check the breaker points and breaker point opening, spark plug, and wiring.*
Carburetor setting incorrect	Adjust; see "Carburetor" on pages 9 and 10.
Poor grade fuel or water in fuel	Drain and use a good grade of clean fuel.
Engine overheating	See "Engine Cooling" See page 19.
Engine valves at fault	*
Engine smokes	Adjust the carburetor. Check for worn piston and rings.*
Other engine problems	*

LACK OF POWER

Air cleaner clogged	Replace the air cleaner element. See page 20.
Engine overloaded	Reduce the load.
Engine overheated	Run the engine until it warms up before putting it under load. See "Engine Overheats" below.*
Poor fuel, too rich, or too lean a mixture	See "Carburetor" on pages 9 and 10.
Fuel tank air vent clogged	Open the vent in the cap.
Air leakage between carburetor and engine	Replace the air cleaner as instructed on page 20. Tighten the carburetor and manifold mounting nuts.
Incorrect timing or faulty ignition	*
Clutch slipping (Models 1000 and 1200)	Adjust the free travel of the pedal; see page 24.
Brake drags	Adjust the brake; see pages 24 to 26.

*See your International Harvester dealer.

TROUBLE SHOOTING

Possible Cause

Possible Remedy

ENGINE OVERHEATS

Insufficient cool air, dirty air intake screen, shroud, or cooling fins	Keep the air intake area and cooling fins clean; see "Engine Cooling and Air Cleaner" on page 20.
Carburetor set to lean	Richen; see carburetor on page 9 and 10.

CREEPING

Speed control out of adjustment (Models 1250, 1450, and 1650) Refer to Service Manual.*
---	-----------------------------

See your International Harvester dealer.

LUBRICATION

The life of any machine depends upon the care it is given. Proper lubrication is a very important part of that care.

ENGINE OIL

The engine crankcase is filled with ship-away oil. This oil may be used for the first 30 hours of engine operation at temperatures between +90 degrees F. and 0 degrees F. If temperatures are not within this range, drain the oil from the crankcase and replace with new oil as specified in the "Lubrication Table". The engine oil must be drained and replaced with new oil every 30 hours of engine operation.

To aid starting, the selection of crankcase lubricating oils should be based on the lowest anticipated temperatures until the next drain period. See page 31.

We recommend IH Low Ash Engine Oil for gasoline engines. IH Low Ash Engine Oil exceeds API Service Classification SE. It is specifically

designed for heavy duty service in gasoline engines, and is formulated to minimize metallic deposits, lengthen spark plug and valve life. IH Low Ash Oil used with unleaded gasoline is the ideal combination to maintain performance and extend engine life.

If other than IH Low Ash Engine Oil is used it must meet API Service Classification SE. For maximum engine life select API SE oils with lowest levels of barium, calcium, or magnesium additives and minimum ash content (approximately 0.5%). Lubricant suppliers will normally furnish this information on their engine oils.

Multi-viscosity numbered oils such as SAE 10W-30 or SAE 10-40 must not be used above 32 degrees Fahrenheit.

LUBRICATION

ENGINE OIL – Continued

Regularly check the oil levels of the engine crankcase and transmission to see that they are filled to the correct levels. **NOTE:** Check the oil level only while the engine is stopped.

Always keep the oil level between the "FULL" and the "LOW" marks on the gauge. When checking the oil level the gauge must be withdrawn and wiped clean, then inserted all the way and withdrawn for a true reading.

NOTE: Never overfill the engine crankcase. Engine damage may result if the crankcase is below the "LOW" mark or over the "FULL" mark.

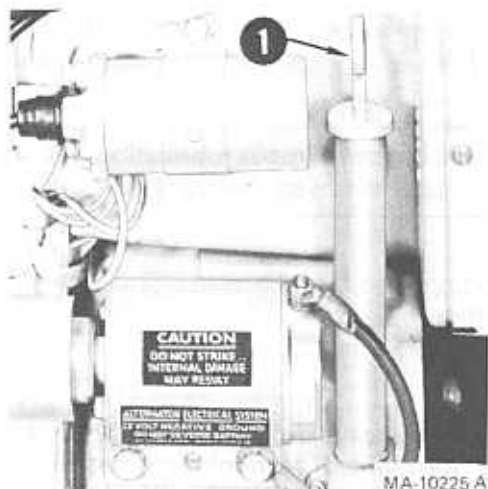

1- Oil filler cap and oil level gauge

NOTE: Right hand side panel removed to show location.

Keep your supply of lubricating oil absolutely clean and free from dust. Always use clean containers. Keep the lubricator clean and wipe dirt from the lubrication fittings before applying the lubricator.

Lubricate the entire tractor, using only high quality lubricating oils and grease as specified in the "Lubrication Table". For your own protection, select only oils and greases of recognized manufacture.

TRANSMISSION OIL FILTER (International Cub Cadet 1250, 1450, and 1650 Tractors)

Remove the throw-away can-type filter and replace with a new filter after the first 10 hours and after 50 hours of operation, and every 100 hours of operation thereafter.

NOTE: Clean the outside area before removing the filter to keep dirt from getting into the transmission case. If a mower is mounted on the tractor, the mower must be lowered to facilitate removal of the filter.

To remove the filter, turn the filter counter-clockwise using an automotive type filter wrench or an open end wrench.

Before installing the new filter, apply a coating of oil on the filter gasket. Thread the filter on by hand until tight enough to seat the gasket. Loosen the filter. Then turn it until the gasket contacts the base. Tighten the filter an additional one half turn. Check for leaks and check oil level of transmission case.

LUBRICATION TABLE

Point of Lubrication	Check at Hours	Change at Hours	Capacity	Anticipated Air Temperature		
				Above +32°F.	+32°F. to 0°F.	Below 0°F.
Engine Crankcase Models 1000, 1200, 1250, 1450 and 1650 Tractors	10	30	3 pt.	I.H. Low Ash Engine Oil SAE-30 Note: Do not substitute 10W-30 or 10W-40	I.H. Low Ash Engine Oil SAE-10W	I.H. No. 1 [®] Engine Oil SAE-5W-20 or SAE-5W
Transmission Models 1250, 1450, and 1650 Tractors	100	Add as needed	14 pt.	<p style="text-align: center;">IH Hy-Tran[®] Fluid</p> <p>If fluid is used which does not meet requirements of IH B-6 Specifications, International Harvester Co. will not be responsible for substandard performance such as lack of proper control, power or premature wear out of hydrostatic transmission and/or hydraulic components. Failures due to use of improper fluid or filters are not covered by warranty. For maximum protection, use IH Hy-Tran Fluid and IH filters.</p>		
Transmission Models 1000 and 1200 Tractors	100	Add as needed	7 pt. Approx.			
Creeper drive housing Models 1000 and 1200 Tractors	100	Add as needed	1/2 pt.			
Steering gear housing. All models	Yearly	—	1/4 lb.	Two strokes of the lubricator using IH-251H EP grease or equivalent #2 multi-purpose lithium grease.		
Steering knuckles All models	10			Use IH-251 IH EP grease or equivalent #2 multi-purpose lithium grease and apply two or three strokes of the lubricator or sufficient grease to flush out old grease and dirt.		
Front wheel bearings	Yearly			Remove front wheels and pack bearings with IH-251H EP grease or equivalent #2 multi-purpose lithium grease and reinstall wheels.		

LUBRICATION GUIDE

International Cub Cadet 1000 and 1200 Tractors

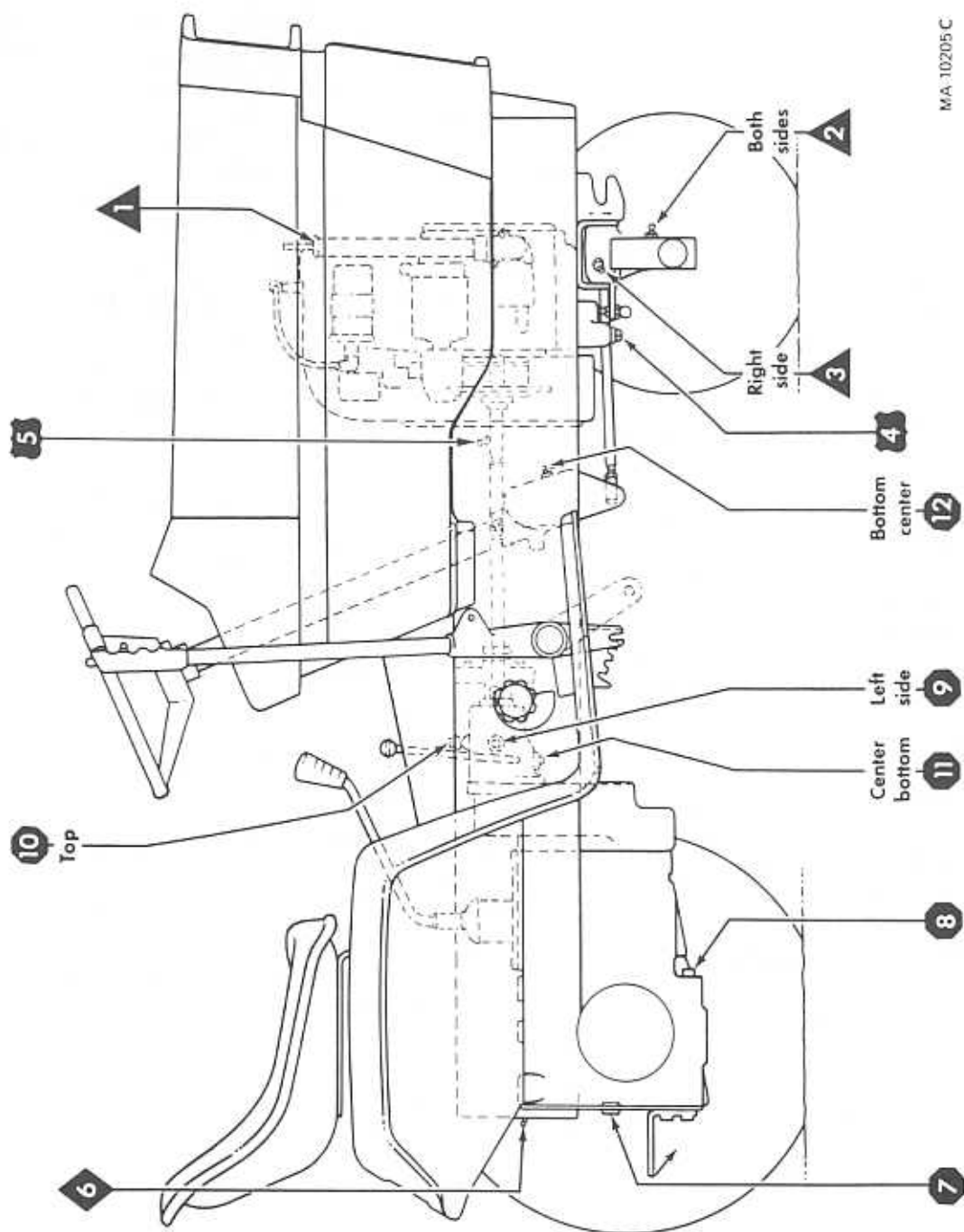

MA 10205 C

Lubrication view.

LUBRICATION GUIDE

International Cub Cadet 1000 and 1200 Tractors



—After Every 10 Hours of Operation

1 - Oil filler cap and bayonet-type oil level gauge

Check the oil (with the engine stopped) and add sufficient new oil to bring it to the "FULL" mark on the gauge. Do not overfill. Do not operate the engine if the oil level is below the "LOW" mark on the gauge.

2 - Steering knuckles (2).

Use IH 251H EP grease or equivalent #2 multi-purpose lithium grease and apply sufficient grease to flush out old grease and dirt.

3 - Front axle pivot pin.

Use IH 251H EP grease or equivalent #2 multi-purpose lithium grease and apply sufficient grease to flush out old grease and dirt. NOTE: It may be necessary to rotate the front axle to reach the grease fitting.



—After Every 30 Hours of Operation

4 - Engine crankcase.

While the oil is warm, remove the drain plug (4) and drain all of the oil from the crankcase. Replace the drain plug. Refill the crankcase with new oil up to the "FULL" mark on the oil level gauge. Refer to the "Lubrication Table" for the proper quantity and viscosity to use.

5 - Clutch shaft.

Remove the frame cover. Using IH 251H EP grease or equivalent No. 2 multi-purpose lithium grease, apply two strokes of lubrication to the fitting.



—After Every 150 Hours of Operation

6 - Power take-off shafting bearing.

Use IH 251H EP grease or equivalent #2 multi-purpose lithium grease and apply two or three strokes of the lubricator to the lubrication fittings.

NOTE: When the red hand of the hour meter is in the red areas maintenance is required.

LUBRICATION GUIDE

International Cub Cadet 1000 and 1200 Tractors



—Periodic

Transmission

- 7 - Oil level and filler plug
- 8 - Oil drain plug.

Check the oil level periodically. Keep the lubricant up the level plug 7 on the rear of the transmission case.

Creeper drive housing

- 9 - Level plug.
- 10 - Breather and filler plug.
- 11 - Drain plug.

Check the oil level periodically. Keep the lubricant up to the level plug 9 on the left side of the creeper drive housing.

12 - Steering gear housing.

Once a year, apply two strokes of the lubricator, using IH 251H EP grease or equivalent #2 multi-purpose lithium grease.

NOTE: To locate the lubrication fitting, remove bottom shield and turn the front wheels to the maximum right turn position. Then reach up under the right side of the tractor frame to locate the fitting.

Miscellaneous

Lubricate the clutch pedal shaft and linkage with eight or ten drops of engine oil.

LUBRICATION GUIDE

International Cub Cadet 1250, 1450 and 1650 Tractors

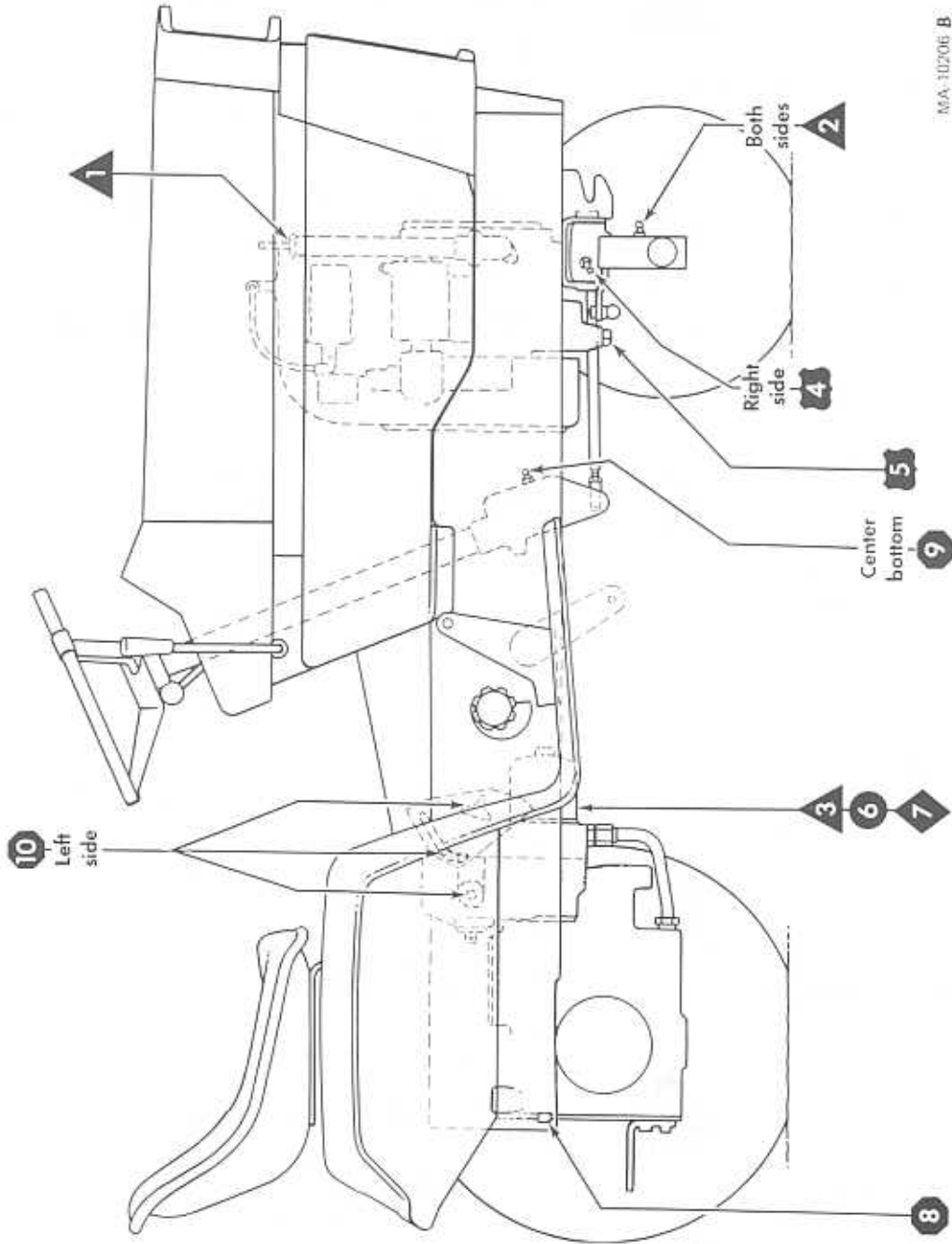

MA-10206 B

Lubrication view.

LUBRICATION GUIDE

International Cub Cadet 1250, 1450 and 1650 Tractors



1. Oil filler cap and bayonet-type oil level gauge

– After Every 10 Hours of Operation

{ Check the oil (with the engine stopped) and add sufficient new oil to bring it to the "FULL" mark on the gauge. Do not overfill. Do not operate the engine if the oil level is below the "LOW" mark on the gauge.

2. Steering Knuckles (2).

{ Use IH 251H EP grease or equivalent #2 multi-purpose lithium grease and apply sufficient grease to flush out old grease and dirt.

3. Transmission oil filter.

{ **NOTE:** After the first 10 hours only, remove the old filter and replace with a new filter as instructed on page 30. Change the oil filter after 50 hours and every 100 hours of operation thereafter.



4. Front Axle pivot pin.

– After Every 30 Hours of Operation

{ Use IH 251H EP grease or equivalent #2 multi-purpose lithium grease and apply sufficient grease to flush out old grease and dirt. **NOTE:** It may be necessary to rotate the front axle to reach the grease fitting.

5. Engine crankcase.

While the oil is warm, remove the drain plug (5) and drain all of the oil from the crankcase. Replace the drain plug. Remove the crankcase oil filler cap (1). Refill the crankcase with new oil up to the "FULL" mark on the oil level gauge. Refer to the "Lubrication Table" for the proper quantity and viscosity to use.



6. Transmission oil filter.

– After Every 50 Hours of Operation

{ **NOTE:** After the first 50 hours only, remove the old filter and replace with a new filter as instructed on page 30. Change the oil filter every 100 hours of operation thereafter.



7. Transmission oil filter.

– After Every 100 Hours of Operation

{ Change the oil filter and replace with a new filter as instructed on page 30,



– Periodic

Transmission

8. Oil level and filler plug

{ Check the oil level periodically. Keep the lubricant up to the level plug (8) on the rear of the transmission case cover.

NOTE: When the red hand of the hour meter is in the red areas maintenance is required.

LUBRICATION GUIDE

International Cub Cadet 1250, 1450, and 1650 Tractors



— Periodic

9. Steering gear housing.

Once a year, apply two strokes of the lubricator, using IH 251H EP grease or equivalent #2 multi-purpose lithium grease.

NOTE: To locate the lubrication fitting, turn the front wheels to the maximum right turn position. Then reach up under the right side of the tractor frame to locate the fitting.

Speed Control Linkage

10. Cam plates

Once a year, apply a light amount of IH 251H EP grease or equivalent #2 multi-purpose lithium grease.

Lubricate the brake pedal shaft and linkage with eight or ten drops of engine oil.

Miscellaneous

If the tractor is equipped with a Three-Point Hitch, once a year the Lift Bar at the implement rockshaft should be lubricated. Apply several strokes of IH 251H EP grease or equivalent #2 multi-purpose lithium grease.

SPECIFICATIONS

REAR POWER TAKE-OFF

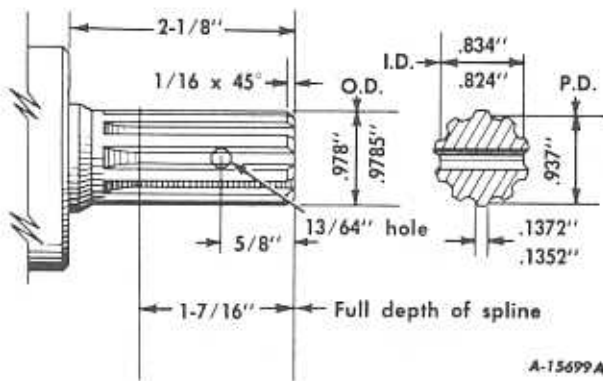

Rear Power take-off shaft spline dimensions
(International Cub Cadet 1000
and 1200 Tractors)

The power take-off shaft connection is a 15/16-inch pitch diameter, ten-tooth involute spline with a 30 degree pressure angle, machines for outside diameter fit. The dimensions are shown.

Power take-off shaft governed
speed 515 r.p.m.

Direction of rotation (looking at rear
of tractor) counterclockwise

Center line of power take-off shaft
above rear axle center of 3-1/4-in.

End of power take-off shaft to rear
of rear axle center line 7-7/16-in.

SPECIFICATIONS

CAPACITIES

(APPROXIMATE —
U.S. MEASURE)

	Model 1000	Model 1200	Model 1250	Model 1450	Model 1650
Fuel Tank	8 qt.	8 qt.	8 qt.	8 qt.	8 qt.
Crankcase	3 pt.	3 pt.	3 pt.	3 pt.	3 pt.
Transmission case	8 pt.	8 pt.	14 pt.	14 pt.	14 pt.
Steering gear housing	1/4 lb.	1/4 lb.	1/4 lb.	1/4 lb.	1/4 lb.
Creeper drive housing	1/2 pt.	1/2 pt.	—	—	—

TRANSMISSION GEARS

Speed: 1st	2.3 mph	2.3 mph	—	—	—
2nd	3.5 mph	3.5 mph	—	—	—
3rd	6.9 mph	6.9 mph	—	—	—
Reverse	2.5 mph	2.5 mph	—	—	—

HYDROSTATIC DRIVE

Speed: Forward	—	—	0 to 8 mph	0 to 8 mph	0 to 8 mph
Reverse	—	—	0 to 4 mph	0 to 4 mph	0 to 4 mph

ENGINE

Make and model	Kohler	Kohler	Kohler	Kohler	Kohler
(electric starting)	K 241 AQS	K 301 AQS	K 301 AQS	K 321 AQS	K 341 AQS
Cylinders	1	1	1	1	1
Bore	3.250	3.375	3.375	3.500	3.750
Stroke	2.875	3.250	3.250	3.250	3.250
Displacement	23.76	29.07	29.07	31.27	35.90
Engine Speed (governed)					
Low Speed	1800 rpm	1800 rpm	1800 rpm	1800 rpm	1800 rpm
High idle speed (no load)	3600 rpm	3600 rpm	3600 rpm	3600 rpm	3600 rpm
Full load	3400 rpm	3400 rpm	3400 rpm	3400 rpm	3400 rpm
Valve clearance (engine cold)010(intake) .020(exh.)	.010(intake) .020(exh.)	.010(intake) .020(exh.)	.010(intake) .020(exh.)	.010(intake) .020(exh.)

SPECIFICATIONS

	Model 1000	Model 1200	Model 1250	Model 1450	Model 1650
ENGINE — Continued					
Ignition (electric starting)	Battery	Battery	Battery	Battery	Battery
Spark plug gap (14mm plug) (Champion RJ-8 or equivalent) (Champion RH-10 or equivalent)	—	—	—	—	—
Breaker points025 in. gap	.025 in. gap	.025 in. gap	.025 in. gap	.025 in. gap
Timing020 in. gap	.020 in. gap	.020 in. gap	.020 in. gap	.020 in. gap
	20 degrees before TDC	20 degrees before TDC	20 degrees before TDC	20 degrees before TDC	20 degrees before TDC

ELECTRICAL SYSTEM

System voltage	12 volt neg. ground	12 volt neg. ground	12 volt neg. ground	12 volt neg. ground	12.volt neg. ground
Battery	9948X	9948X	9948X	9948X	9948X
Alternator	15 amp.	15 amp.	15 amp.	15 amp.	15 amp.
Fuse (cartridge type) (1 or 2)	AGC-10 amp. Slow Blow	AGC-10 amp. Slow Blow	AGC-10 amp. Slow Blow	AGC-10 amp. Slow Blow	AGC-10 amp. Slow Blow

Headlights — all glass, sealed beam units	Lamp No. 4411	IH Part No. 373 662 R91
Taillight	67	142 450

SPECIFICATIONS

FOOT BRAKE

Rear wheel disc type, mechanical, on both rear wheels 8 in. dia.

CLUTCH

Double-plate, dry disc, spring loaded (Models 800, 100 and 1200 Tractors) 4-1/2 in.

TIRE SIZES

Front	Models 1000, 1200, and 1250 Tractors	4.80/4.00-8
	Models 1450 and 1650	16 x 6.50-8
Rear	Model 1000 Tractor	6-12
	Models 1200, 1250, and 1450 Tractors	23 x 8.50-12
	Model 1650 Tractor	23 x 10.50-12

DIMENSIONS

Tread:		
Front:		
With 4.80/4.00-8 tires		27.0-in.
With 16 x 6.50-8 floatation tires		28.6-in.
Rear		27.0-in.
Wheelbase		44-in.
Length, over-all		69-in.
Width, over-all		
Model 1000 Tractor		33-in.
Model 1200, 1250, and 1450 Tractors		37-in.
Model 1650 Tractor		39-in.
Height, over-all (to top of steering wheel)		41-in.
Ground clearance		6-in.
Turning radius		6.6 ft.

Specifications are subject to change without notice.

Accidents can be prevented with your help

No accident-prevention program can be successful without the wholehearted co-operation of the person who is directly responsible for the operation of equipment.

To read accident reports from all over the country is to be convinced that a large number of accidents can be prevented only by the operator anticipating the result before the accident is caused and doing something about it. No power-driven equipment, whether it be transportation or processing, whether it be on the highway, in the harvest field or in the

industrial plant, can be safer than the man who is at the controls. If accidents are to be prevented—and they can be prevented—it will be done by the operators who accept a full measure of their responsibility.

It is true that the designer, the manufacturer, the safety engineer can help; and they will help, but their combined efforts can be wiped out by a single careless act of the operator.

It is said that "*the best kind of a safety device is a careful operator.*" We ask you to be that kind of an operator.

